

# UserGuide

## LANEXPERT™ Inline Gigabit Network Analyzer

Tips for viewing PDFs:

- To use thumbnails, click the Thumbnail tab, and double-click on the page number you want to view (The page will appear on the right side of your screen.)
- To print, specify a range of pages in the Acrobat Print dialog box, or specify non-contiguous pages or a particular page before opening the dialog box. Click the Print button or choose File>Print.
- This User guide is for the models **LANEXPERT™ 80** and **LANEXPERT™ 85**. Some features will be applicable for only the **LANEXPERT™ 80** or **LANEXPERT™ 85**. These features will be sited on the individual pages in the manual.

For more information, select Help> Reader Guide from the Acrobat window.

### If you need assistance:

#### Customer Support -

- 8am to 5pm PST ----- (619) 287-9970
- [support@psiber.com](mailto:support@psiber.com)

---

## Copyright

This guide is copyrighted by Psiber Data Systems Inc. with all rights reserved. Under the copyright laws, this guide cannot be reproduced in any form without the prior written permission of Psiber Data Systems Inc. No patent liability is assumed, however, with respect to the use of the information contained herein.

© 2008-2011 by Psiber Data Systems Inc. All rights reserved.

## Notice

The information contained in this manual, including but not limited to any product specifications, is subject to change without notice.

**PSIBER DATA SYSTEMS INC. AND PSIBER DATA GMBH (PSIBER) PROVIDE NO WARRANTY WITH REGARD TO THIS MANUAL OR ANY OTHER INFORMATION CONTAINED HEREIN AND HEREBY EXPRESSLY DISCLAIM ANY IMPLIED WARRANTIES OF MERCHANTABILITY OR FITNESS FOR ANY PARTICULAR PURPOSE WITH REGARD TO ANY OF THE FOREGOING. PSIBER ASSUMES NO LIABILITY FOR ANY DAMAGES INCURRED DIRECTLY OR INDIRECTLY FROM ANY TECHNICAL OR TYPOGRAPHICAL ERRORS OR OMISSIONS CONTAINED HEREIN OR FOR DISCREPANCIES BETWEEN PRODUCT AND THE MANUAL. IN NO EVENT SHALL PSIBER BE LIABLE FOR ANY INCIDENTAL, CONSEQUENTIAL, SPECIAL, OR EXEMPLARY DAMAGES, WHETHER BASED ON TORT, CONTRACT OR OTHERWISE, ARISING OUT OF OR IN CONNECTION WITH THIS MANUAL OR ANY OTHER INFORMATION CONTAINED HEREIN OR THE USE THEREOF.**

## Trademarks

The Psiber Logo, Psiber and LanExpert are trademarks of Psiber Data Systems Inc.

All other brands and product names are trademarks or registered trademarks of their respective companies.

# Table of Contents

---

<i>Introduction</i>		<i>vix</i>
<b>Chapter 1</b>	<b>Finding Your Way Around</b>	<b>1-1</b>
	Make Sure You Have Everthing	1-1
	Front Port View	1-2
	Rear Port View	1-3
	Display View	1-4
<b>Chapter 2</b>	<b>Getting Started</b>	<b>2-1</b>
	Preparing the Unit	2-1
	Initial Startup of Analyzer	2-2
	Connecting AC Adapter	2-2
	Charging the Battery	2-3
	Using the Analyzer for First Time	2-4
	Power On	2-4
	Setting Time and Date	2-4
	Setting Power Options	2-5
	Setting Illumination Options	2-5
	Status Indicators	2-6
	Navigating the Screen	2-7
	Active Buttons	2-8
	Battery Symbol	2-8

---

<b>Chapter 3</b>	<b>Setup</b>	<b>3-1</b>
	Navigating to Setup Screens	3-1
	Select Profile	3-2
	Profile Name	3-3
	Ports	3-4
	Ports Configuration	3-4
	Link As	3-5
	Speed/Duplex	3-5
	Transmit	3-6
	Tag	3-6
	MAC	3-7
	IP Address	3-8
	Link Search Timeout	3-9
	Link Lost Timeout	3-9
	EXT Server Timeout	3-9
	Protocols	3-10
	Ephemeral Ports	3-10
	User Defined	3-10
	Ping/Trace	3-11
	Repeat	3-11
	Max Rate	3-11
	Payload	3-11
	Timeout	3-12

---

Ping Targets	3-12
Gateway	3-12
DHCP Server	3-12
IP Range	3-13
Ping List Entries 1 to 16	3-13
Discover	3-14
Traffic Generation	3-15
Duration	3-15
Size	3-15
Rate	3-16
Sink IP	3-16
Check Sum	3-16
Stress Test	3-17
Remote IP	3-17
Frame Size	3-17
Max Bit Rate	3-17
Max Frame Rate	3-17
Inter-test Delay	3-17
Accuracy	3-18
Throughput	3-18
Latency	3-18
Frame Loss	3-19
Back to Back	3-19

---

Capture	3-20	
Capture Source MAC	3-20	
Capture Destination MAC	3-20	
Capture Frame Type	3-21	
Capture VLAN Frames	3-21	
Capture Primary Protocols	3-22	
Capture Source IP	3-23	
Capture Destination IP	3-23	
Capture IP Protocols	3-23	
Capture UDP/TCP Ports	3-24	
Lock	3-25	
Colors	3-26	
Build Info	3-27	
Select Language	3-27	
<b>Chapter 4</b>	<b>Analyze the Network</b>	<b>4-1</b>
Prepare to Use the Analyzer	4-1	
Selecting the Test Mode	4-2	
Link	4-2	
Partner Capability	4-2	
Signals	4-2	
Relink	4-3	
Link IP Information	4-3	

---

Port Info	4-4	
Expert	4-5	
Vitals	4-9	
Good Frames	4-10	
Good Bytes	4-10	
Bad Frames	4-10	
Protocols	4-11	
Top Talkers	4-13	
Devices	4-14	
Ping/Trace	4-15	
Tracert	4-15	
Traffic Generate	4-16	
Email	4-17	
VoIP	4-18	
Frame Capture	4-24	
Remote Access	4-25	
Inline PoE	4-26	
Save	4-27	
Setup	4-28	
<b>Chapter 5</b>	<b>Stress Test</b>	<b>5-1</b>
Understanding RFC2544		5-1
Stress Test Basic Setup		5-2
Stress Test home Screen		5-4
Throughput		5-6
Latency		5-7
Frame Loss		5-8

---

	Back-to-Back	5-9
	Basic Storage	5-10
<b>Chapter 6</b>	<b>Cable Test (LE80 ONLY)</b>	<b>6-1</b>
	Port Identification	6-2
	Tone	6-2
	Length	6-3
	Wiremap	6-4
	PoE	6-5
<b>Chapter 7</b>	<b>Loopback</b>	<b>7-1</b>
	Setup Loopback Mode	7-2
<b>Chapter 8</b>	<b>Recall Saved Data</b>	<b>8-1</b>
	Recall Internal Data	8-2
	Recall External Data	8-3
<b>Chapter 9</b>	<b>Technical Support</b>	<b>9-1</b>
<b>Chapter 10</b>	<b>Update Firmware</b>	<b>10-1</b>
	Install Console Application	10-2
	Firmware Update Instructions	10-3
<b>Appendix A</b>	<b>Connecting the Analyzer</b>	<b>A-1</b>
<b>Appendix B</b>	<b>Graphics</b>	<b>B-1</b>
<b>Appendix C</b>	<b>UTC Time Zones</b>	<b>C-1</b>

# Introduction

---

The **LANEXPERT** Inline Gigabit Network Analyzer is a handheld network tool that features protocol analysis, packet capture, traffic generation, cable testing and IPv4/IPv6 support. The **LANEXPERT** utilizes a color touch screen interface to access one of the most complete suites of test and analysis functions available in a portable test tool. The Inline Mode allows users to non-intrusively monitor network traffic (10/100/1000BaseTX) to identify protocols, port usage, VoIP statistics and network utilization. The **LANEXPERT** can capture and store up to 10,000 packets with user defined filters for detailed analysis in the field, downloaded over the network or to a USB flash drive. Use either RJ-45 port to test Ping, Link, Trace Route, DHCP and Discovery which will quickly identify network problems. The **LANEXPERT** can generate up to 100% traffic loading in 1% increments to demonstrate network performance at various traffic levels. A stress test that generates traffic and measures performance metrics (per RFC 2544) is also provided. The stress test can be conducted using the two independent ports on a single unit or used with a second unit located remotely on a network. PoE tests include voltage and inline current measurement to determine the actual power used by a powered device. The **LANEXPERT** also tests cable for shorts, opens, split pairs, reversed pairs, measures cable length and generates tones for cable tracing.

## This Guide

This guide introduces the analyzer's features.

You can:

- Read the entire guide beginning to end.
- Skim through and stop when a topic interests you.
- Use the table of contents and index to find specific information.

Read through Part I to familiarize yourself with the parts of the analyzer.

---

## Other Documentation

In addition to this user's guide, the **LANEXPERT** comes with the following documentation:

- A Quick Start Guide which explains the basics to get started analyzing networks quickly.
- Electronic help and definition pages built into every screen displayed on the **LANEXPERT**.
- Update help and information available at our web site.

## Warranty/Service option

Psiber Data Systems Inc. warrants that the product shall be free from defects in parts or workmanship for a period of 12 months from the date of purchase if used in accordance with Psiber Data Systems Inc. operating specifications.

**THIS IS THE ONLY WARRANTY MADE BY PSIBER DATA SYSTEMS INC. AND IS EXPRESSLY MADE IN LIEU OF ALL OTHER WARRANTIES, EXPRESSED OR IMPLIED, INCLUDING BUT NOT LIMITED TO ANY IMPLIED WARRANTIES OF MERCHANTABILITY OR FITNESS FOR ANY PARTICULAR PURPOSE.**

Should any parts or workmanship prove defective, Psiber Data Systems Inc. will repair or replace at Psiber's discretion, with no cost to the Buyer except for shipping costs from the Buyer's location to Psiber's location. This is the Buyer's **SOLE AND EXCLUSIVE REMEDY** under this agreement. This warranty does not apply to products which have been subject to neglect, accident or improper use, or to units which have been altered or repaired by other than an authorized repair facility.

Return of Equipment - Return of product to Psiber Data Systems Inc. requires a Return Merchandise Authorization (RMA) issued by Customer Service. To obtain an RMA, contact us at 619-287-9970 (8am to 4pm PST) or email support@psiber.com. The RMA# must be clearly marked on the shipping label or package. See sample label:

**To: Psiber Data Systems Inc.  
7075-K Mission Gorge Rd.  
San Diego, CA 92120  
RMA# XXXXXXX**

# Chapter 1

---

# Finding Your Way Around

---

This chapter presents a tour of the Network Analyzer and serves as a reference to locate specific parts of the analyzer.

## Make Sure You Have Everything

This section lists all items to be included with the **LANEXPERT™** Network Analyzer.

- **LANEXPERT** Gigabit Inline Network Analyzer
- **LANEXPERT** Wiremap Terminator (LE80)
- USB Flash Drive (Contains User Guide and Console Application)
- AC Adapter with Country Specific Power Cord
- RJ45 Patch Cable
- Wrist Strap
- Quick Start Guide
- Carrying Case with Removable Shoulder Strap
- SFP Modules:
  - Two Single Mode (LE85S)    -Two Multimode (LE85M)
  - One 10/100/1000BaseT(LE85)
- Two Fiber Patch Cables (LE85)

Notify supplier immediately of any missing or damaged items.

## Front Port View

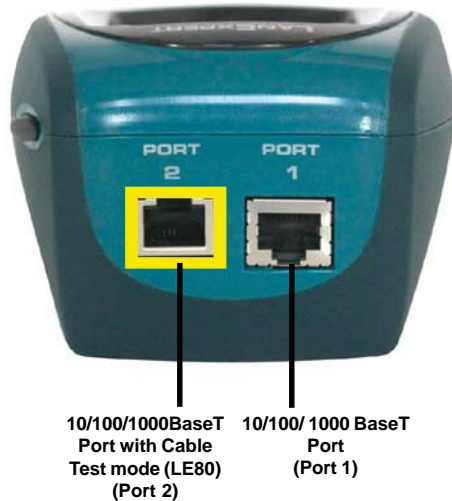

Port 1 is a 10/100/1000BaseT RJ-45 Port.

Port 2 is a 10/100/1000BaseT RJ-45 Port with Cable Test modes (LE80). For more information on the Cable test performed by the **LANEXPERT 80** go to chapter 6, page 6-1.

Both ports can be used simultaneously when running Inline, Independent and Stress Test modes.



## Rear Port View

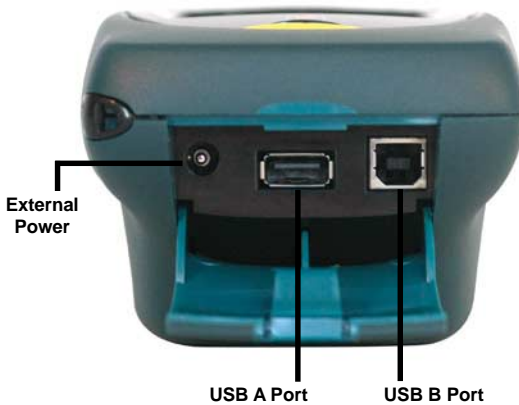

Use the External Power jack to plug in the AC adapter. For more information, see Connecting the AC adapter in Chapter 2 page 2-2.

The USB A Port is used to plug in the Flash Drive to save data externally.

The USB B Port will connect the **LANEXPERT** to your computer. This feature is for future use.

## Display View



The Status indicators provide information about various functions of the analyzer. For more information, see Status Indicators (LEDs) in Chapter 2 on page 2-6.

The Display/Touchscreen area is the interface for the **LANEXPERT**. For more information see Navigating the Screen in Chapter 2 on page 2-7.

The Power button turns the **LANEXPERT** on and off. For more information see Power On Chapter 2 on page 2-4.

# Chapter 2

---

# Getting Started

---

This chapter describes how to connect the **LANEXPERT** to other devices and how to operate the Network Analyzer.

## Preparing the Unit

The **LANEXPERT** Network Analyzer is portable and designed to be used in a variety of circumstances and locations. The analyzer can be hand-held or placed on a surface large enough for stable use. The analyzer has an optional wrist strap to securely tether the unit to the wrist to avoid dropping.

## Environment

To keep your analyzer in prime operating condition, protect the unit from:

- Dust, moisture and direct sunlight.
- Liquids and corrosive materials.
- Equipment that generates a strong electromagnetic field.
- Rapid changes in temperature or humidity.
- Extreme heat or cold. Operate the analyzer within the specified temperature range.

---

## Precautions

Your **LANEXPERT** Network Analyzer is designed to withstand the rigors of everyday use and travel. However, you should observe certain precautions to further reduce the risk of personal injury or damage to the analyzer.

- Never apply heavy pressure to the analyzer, especially on or around the display area. Avoid sharp impacts to the analyzer. Excessive pressure or impact can damage components or otherwise cause the analyzer to malfunction.
- Do not submerge, float or allow liquids to spill into or onto the analyzer.
- Do not use excessive force to connect or disconnect cables or peripherals.
- Use wrist strap to prevent accidentally dropping the analyzer.
- Never use sharp objects on the display / touchscreen area. Use the supplied stylus.

## Initial Start Up of Analyzer

The analyzer contains a rechargeable battery pack which needs to be fully charged before use for any length of time. The battery pack will come with enough charge to power up the analyzer and perform a few tasks but, should then be connected to the AC adapter and allowed to fully charge.

## Connecting the AC Adapter

The AC adapter provides power to the analyzer from an AC outlet and charges the analyzer's battery pack.



AC adapter and power cable

To connect AC power to analyzer:

- Connect the power cable to the AC adapter.
- Plug the AC adapter into the analyzer's External Power jack.
- Connect the power cable to a live AC outlet.

---

*DANGER: To avoid electric shock, never modify, forcibly bend, damage, apply heat to or place heavy objects on top of power cord. If power cable becomes damaged or plug overheats, discontinue use.*

*Never remove the power plug from the outlet with wet hands.*

---

*CAUTION: Using the wrong AC adapter could damage your analyzer. Psiber assumes no liability for damage in such cases.*

*Never pull directly on the power cable to unplug it. Hold the power plug when removing the cable from the outlet.*

---

## Charging the Battery

Before using the battery pack to power the analyzer for any length of time, it must be fully charged. Connect the analyzer to a live AC outlet using the AC adapter and power cable.

The battery pack can be charged with the analyzer turned on or off. Charging time is reduced if the analyzer is turned off. With the analyzer turned on, the Status indicator and Battery symbol on the display provides the charge status of the battery pack.

For more information on the Status indicators and the Battery icon, see Status indicators on page 2-6 and Battery symbol on page 2-8.

# Using the Analyzer for the First Time

## Power on

- Turn on the **LANEXPERT** by pressing the power button until the screen lights up, then release the button.
- The unit displays the Welcome screen for approximately 3 seconds. The firmware revision is shown on this screen. The **HOME** screen is then automatically displayed to select an operating mode.

## Setting time and date

Initially the analyzer comes from the factory without the time and date set. There will be red dashes in place of the numbers.



Red Dashes

- Click on dashes or displayed time to access **TIME/DATE** screen.
- Select the time format for use as either 12hr or 24hr.
- Select the date format for use as DD/MM/YY, MM/DD/YY or YY/MM/DD.
- Select the correct time zone in relation to UTC time by using the up and down arrows. Use the up or down arrows to set time and date.

The time and date will automatically update to preview your selections.

*NOTE: The **LANEXPERT** does not automatically update for daylight savings time.*



Time/Date Screen

## Setting power options

Select the **Battery Symbol** in the top right of the screen. The **POWER** screen displays power timing options and illumination settings.



Power Screen

There are three options for **BATTERY** power off times; **Default (Factory Set)**, **Other** and **Stay On**. Select an option by clicking the box to the left of the name. The option is selected when the box is filled.

For example, if the default is 5 minutes, then after 5 minutes of inactive use the unit will display a brief message indicating it will shut down unless the user touches the screen.

If selecting **Other** under either the **BATTERY** or **AC** power, then the user can change the time by pressing on the button to the right of the word. A numerical keyboard is displayed. After selecting the desired numbers, select **ENTER** to go back to the **POWER** screen.

## Setting illumination options

The Illumination of the **Backlight** of the display and the **LEDs** intensity can be adjusted on the **Power** Screen as well. The brightness options for both are lowest at the leftmost and progressively brighten as boxes to the right are selected.

## Status Indicators



Status Indicators

From left to right, the indicators are **Power, Port 1, Port 2, and Activity**.

- **Power** - shows battery and external power status.
  - **Green** - Battery has more than 25% charge.
  - **Red** - Battery has less than 25% charge.
  - **Orange** - External power connected.
  
- **Port 1 and Port 2** - shows the status of each port when it is connected.
  - **Green** - connected at 1 Gbit
  - **Orange** - connected at 100Mbit
  - **Red** - connected at 10Mbit
  - **Flashing Red** - trying to link.
  - **Off** - not trying to Link or is not linked.
  
- **Activity** - shows network activity on either port when the LANEXPERT receives a frame.
  - **Green** indicates a good frame is detected
  - **Red** indicates a bad frame is detected.

---

*NOTE: When monitoring heavy network traffic, the Activity Indicator appears to stay on continuously, even with a steady flow of good traffic indicated.*

---

## Navigating the Screen

The LanExpert's touch screen display has five distinct areas. The layout for all screens is the same except for the home screen.

- **Top Area** displays (from left to right) Mode Identifier Graphic, Screen Title, Time, Battery, Help and Exit buttons.
- **Bottom Area** consists of a left scroll button, three graphical icon buttons and a right scroll button.
- **Data Area** is the main portion of the screen between the top area and the bottom area. This area will display all the information, data, measurements and detection results.
- **Data Action Buttons** are selectable buttons directly above the bottom section. These buttons appear only on certain screens. They perform actions pertinent only to the displayed screen (i.e. data clear, start test, stop test or data format selection buttons).
- **Data Scroll Bar** is on the left hand side of the screen. This scrolls up and down to view more test results or configurations.

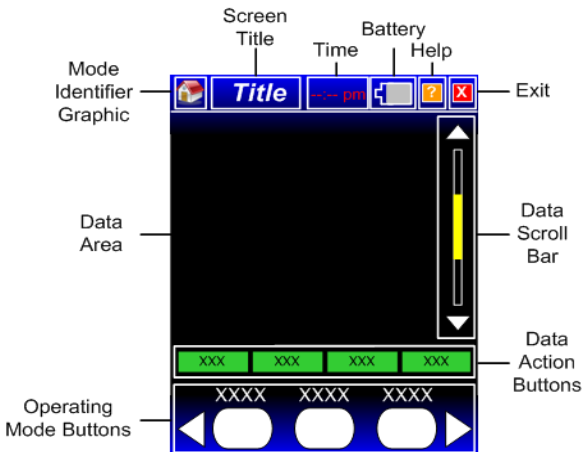

Screen Areas

## Active Buttons

### Help

Select the **Question Mark** button next to the Battery Symbol. This screen displays helpful information for the specific screen being used. Information could be definitions, step-by-step instructions or other useful information. Select the Exit button to return to the previous screen.

### Exit

Select the **Exit** button at the far right in the Top Area. By pressing this button, the LanExpert reverts back to the previous screen.

## Battery Symbol

The battery status symbol fills from the right and indicates the approximate percentage of battery charge available. A full battery will be completely gray with a white outline.



Battery Power ONLY: 20% or more power remaining.  
(Gray with White Outline)



Battery Power ONLY: 20% or less power remaining.  
(Yellow with White Outline)



Battery Power ONLY: 5% or less power remaining.  
(Red with White Outline)



AC and Battery Power connected with 100% fully charged battery.  
(Solid Green with White Outline)



Battery is charging, the symbol will pulse green from the right to the approximate current charge level.  
(Solid Green with White Outline)



Battery fault, the battery is not connected or the Battery needs to be replaced. (Black with Red Outline)

# Chapter 3

---

# Setup

This chapter describes how to configure the **LANEXPERT** using the setup screens.

## Navigating to Setup Screens

Select the **SETUP** button from the **HOME** screen. The available configurable categories are displayed at the bottom of the screen. Use the left and right scroll arrows to select a different category. When completed with any setup configuration, select the EXIT button to return to the previous screen or Home screen.

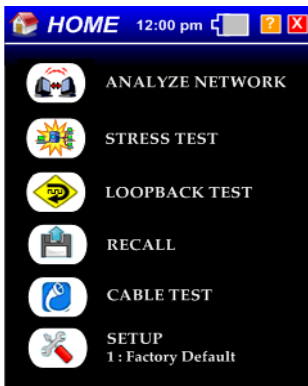

Home Screen LE80

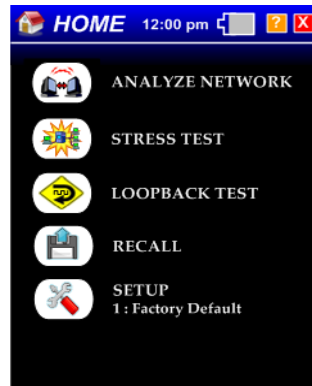

Home Screen LE85

## Select Profile

**SELECT PROFILE** shows a listing of all the profile names. There are 49 changeable profiles and one factory default. The factory default profile **cannot** be changed. Select a profile by clicking on the box to the left. This will enable the stored parameters to be used for testing.

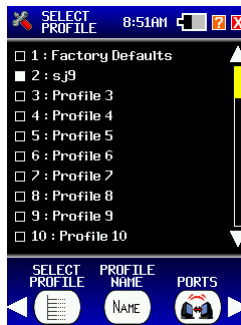

Select Profile Screen

*NOTE: Select another Setup button visible on the screen or by scrolling to the right or left with the white arrows or select the Exit button.*

## Profile Name

**PROFILE NAME** button changes the name of the **SELECTED** profile (indicated by a filled white box). A screen with an alphanumeric keyboard will appear. Select **CLEAR** to remove the currently displayed name. Choose any name with up to 16 characters. If there are more than 16 characters detected, an error screen will indicate “too many characters”. Select **CLEAR** and re-enter a new profile name. If no characters were entered for a name and **ENTER** is selected, an error message will indicate “too few characters”. After entering a correct profile name, select **ENTER** to return to the **SELECT PROFILE** screen.

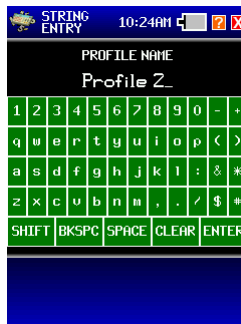

Full Keyboard

*NOTE: Select another Setup button visible on the screen or by scrolling to the right or left with the white arrows or select the Exit button.*

## Ports

To edit or view the parameters for the **SELECTED** profile, select the button called **PORTS**.

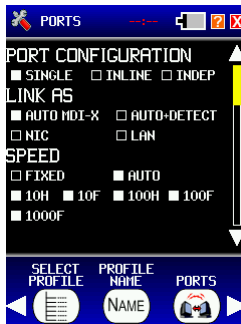

Single Mode

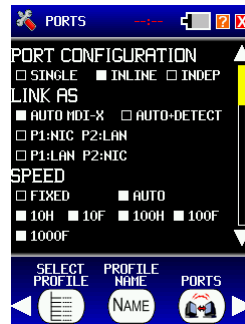

Inline Mode

## Port Configuration

**PORT CONFIGURATION** has three modes the unit can be set to: **SINGLE**, **INLINE** or **INDEP (INDEPENDENT)**. See Configurations in Appendix A, page 64 for more details on how to connect the **LANEXPERT**.

- **SINGLE** mode connects one port on the LanExpert straight into a hub, switch or network device. **SINGLE** mode can be plugged into either Port 1 or Port 2. If both Ports are plugged in at the same time, then whichever Port links first will be enabled. This will cause the unused port to be disabled. The LEDs will indicate which Port is linked.
- **INLINE** mode must have both ports connected to two network devices. **INLINE** mode can be used to observe the traffic flowing between two network devices. Disconnect the cable between the two network devices and connect one end into Port 1. Add a patch cable from the other network device into Port 2. The LanExpert is now between the two network devices. If a Port is not plugged in, the corresponding LED will flash red to indicate that no cable is plugged in.
- **INDEPENDENT** mode must also have both Ports connected to one or two network devices. **INDEPENDENT** mode can inject variable traffic from one port onto the network while the other port listens to investigate the effects on the network. **INDEPENDENT** mode can monitor two separate network devices simultaneously. If **INDEPENDENT** mode is selected then both Ports 1 and 2 will need to be configured independently.

---

*NOTE: If **INDEPENDENT** mode is selected, Port 1 parameters will be configured first. Port 2 parameters will then be available. The parameters will be port identified for clarity.*

---

## Link As

**LINK AS** parameter determines whether the **LANEXPERT** is going to connect as an **Auto MDI-X**, **Auto + Detect**, **LAN** or **NIC** device on the network.

- **Auto MDI-X** will auto crossover the port (LAN or NIC). It will link at the first compatible mode to provide faster testing.
- **Auto + Detect** will auto crossover the port (LAN or NIC) and give more link information than auto MDI-X. It will test for all modes available before linking and will display the configuration for the link partners. Some SOHO (Small office, home office) gigabit switches are not fully compatible with **Auto + Detect** detection.
- **LAN** will force the analyzer's port to look like a switch or a hub to the device it is connected to.
- **NIC** will force the analyzer's port to look like a PC to the device it is connected to.

In **INLINE** mode, there are two additional options of forcing Port 1 to connect as NIC while Port 2 connects as LAN (**P1: NIC P2: LAN**) or vice versa (**P1: LAN P2: NIC**).

## Speed/Duplex

**SPEED/DUPLEX** parameter can be conducted in an **Auto**-negotiating mode or forced to a single **FIXED** speed/duplex . For **AUTO**, select any combination of the five speed/duplex modes; 10H, 10F, 100H, 100F or 1000F. In **FIXED**, only **ONE** port speed/duplex can be selected.

---

*NOTE: Press the **DOWN** arrow on the right of the screen to scroll to the next page of parameters.*

---

## Transmit

**TRANSMIT** parameter displays how the LanExpert communicates with the user's network, i.e. **DISABLED**, **RFC894**, **LLC/SNAP** or **VLAN**.

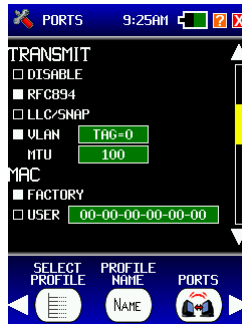

Ports Setup Screen II

- **DISABLE** turns off all packet generation for non-intrusive testing. No IP address is required for this configuration.
- **RFC894** enables packet transmission. This protocol is the most common standard using IP datagrams.
- **LLC/SNAP** enables packet transmission. It is a legacy standard using IEEE 802.2 frames.
- **VLAN** logically groups computers together across one or more switches. (For example the IT Department VLAN). The VLAN Identifier or tag specifies the VLAN to which the frame belongs. A value of 0 means the frame is not assigned to any VLAN. All other values may be used as VLAN identifiers allowing up to 4095 VLANs. VLAN 1 is often reserved for management of a network bridge.

## Tag

Next to **VLAN**, the user can select or change the **TAG** number if there is more than one. Select the **TAG=?** button. A numerical keyboard screen is displayed. Valid entries are 0 to 4095. If a non-valid entry is chosen, then an error message will appear indicating the error. The screen will then revert back to the keyboard to re-enter a valid number. The **CLEAR** button removes the incorrect entered digits from the display. After selecting a valid number, select **ENTER** to return to the **PORTS** parameters screen.

---

## Transmit - cont.

- **MTU** is used to set the size (in bytes) of the largest frame that a given layer of a communications protocol can process. A higher MTU brings higher bandwidth efficiency. Not all network devices can process large packets which can reduce network performance.

Select the parameter button next to **MTU**. A numerical keyboard screen will be displayed. Valid entries are 100 to 1518. If a non-valid entry is chosen, an error message will appear indicating the error. The screen will then revert back to the keyboard to re-enter a valid number. The **CLEAR** button removes the incorrect digits from the display. After selecting a valid number, select **ENTER** to return to the **PORTS** parameters screen.

## MAC

**MAC** address parameters are displayed. The user has a choice of the **FACTORY** or **USER** MAC address.

- **FACTORY** - MAC Address of the **LANEXPERT** is factory set and **CANNOT** be changed.
- **USER** - User can enter a MAC address of their choice for device cloning purposes. MAC cloning allows the LanExpert to simulate another network device by using its own MAC address to detect issues originating from that device. Select the address button to go to a Hexadecimal keyboard screen to enter a MAC address. The **CLEAR** button removes the entered digits from the display before entering a new address. After entering the desired address, select **ENTER** to return to the **PORTS** parameters screen.

---

*NOTE: Press the DOWN arrow on the right of the screen to scroll to the next page of parameters.*

---

## IP Address

**IP ADDRESS** parameters allow selection of **IPv4** and **FIXED** or **DHCP**. This must match the network to which the **LANEXPERT** is being connected.

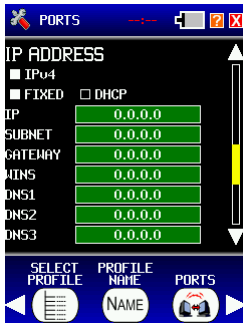

Ports Setup Screen III Fixed

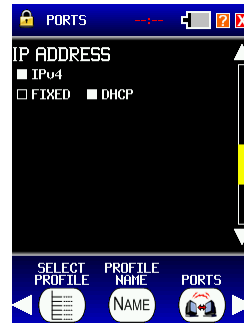

Ports Setup Screen III DHCP

- **IPv4** - is a protocol type to be used for all transmitted packets used by traffic generation, PING, DHCP and other tests.
- **FIXED** allows the IP, Subnet, Gateway, WINS, DNS1, DNS2 and DNS3 fields to be available to change. Selecting the button next to the name displays a numerical keyboard to enter the desired address. After entering the desired addresses, select **ENTER** to return to the **PORTS** parameters screen.
- **DHCP** causes the IP, Subnet, Gateway, WINS, DNS1, DNS2 and DNS3 fields not to appear because they are unavailable for change. These will automatically be assigned to the **LANEXPERT** once a link is established with the DHCP server.

---

*NOTE: If **INDEPENDENT** mode is selected, Port 1 parameters will be configured first, then Port 2 parameters will be available. The parameters will be port identified for clarity.*

---

---

*NOTE: Press the **DOWN** arrow on the right of the screen to scroll to the next page of parameters.*

---

---

## Link Search Timeout

**LINK SEARCH TIMEOUT** allows the user to select either 5s (factory default) or Other. Link Search Timeout is the time it takes, in seconds, for the **LANEXPERT** to acquire a link before it determines there is no link. Select the **Other** button then select the Time button to the right to change the parameter. This will display a numerical keyboard screen. Valid entries are 1 to 99. After entering a valid time, select **ENTER** to return to the **PORTS** parameters.

## Link Lost Timeout

**LINK LOST TIMEOUT** allows the user to select either 3s (factory default) or Other. Link Lost Timeout is the time it takes, in seconds, to determine when there is a lost link after the link was established. Select the **Other** button then select the Time button to the right to change the parameter. This will display a numerical keyboard screen. Valid entries are 1 to 99. After entering a valid time, select **ENTER** to return to the **PORTS** parameters.

## Ext Server Timeout

**EXT SERVER TIMEOUT** allows the user to select either 10s (factory default) or Other. Ext Server Timeout is the time it takes, in seconds, to determine when there is no external server present. Select the **Other** button then select the Time button to the right to change the parameter. This will display a numerical keyboard screen. Valid entries are 1 to 99. After entering a valid time, select **ENTER** to return to the **PORTS** parameters.

---

*NOTE: Select another Setup button visible on the screen or by scrolling to the right or left with the white arrows or select the Exit button.*

---

## Protocols

To edit or view the parameters for the **SELECTED** profile, select the **PROTOCOLS** button.



Protocols Screen

## Ephemeral Ports

**EPHEMERAL PORTS** are temporary ports that are used by clients to communicate with a server. These temporary ports within the defined range are disregarded by the **LANEXPERT**. Select either of the numbered buttons to change the range of ephemeral ports. This will display a numerical keyboard. Valid entries are 0 to 65535. After selecting valid numbers, select **ENTER** to return to the **PROTOCOLS** parameters.

## User Defined

**USER DEFINED** ports allow the user to enter unique port names and numbers. Select whether the port is a TCP, UDP or Both. User defined ports take priority over any other factory defined port definition. For example; Port 80 is HTTP (80:HTTP) but, if the user defines port 80 to be named Factory it will display Factory instead of HTTP (80:Factory) under the **PROTOCOLS** screen.

**Port Names** and **Numbers** can be entered or changed by selecting either the name or number button. This will display either an alphanumeric or numerical keyboard screen. Valid Port Names are a maximum of 10 characters. Valid Port Number entries are 0 to 65535. After entering a valid name or number, select **ENTER** to return to the **PROTOCOLS** parameters.

*NOTE: Select another Setup button visible on the screen or by scrolling to the right or left with the white arrows or select the Exit button.*

## Ping/Trace

To edit or view the parameters for the **SELECTED** profile, select the **PING/TRACE** button.

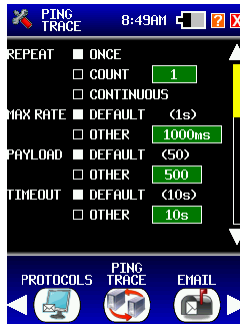

Ping /Trace Screen 1

### Repeat

**REPEAT** determines the number of times to ping a device. Ping is a network tool used to test whether a particular host is reachable across an IP network. There are three options; Once, Count or Continuous. Select the Count button then select the number field to the right to change the parameter. This will display a numerical keyboard screen. Valid entries are 1 to 999. After entering a valid number, select **ENTER** to return to the **PING/TRACE** parameters.

### Max Rate

**MAX RATE** is the maximum time between sending one ping to sending the next. There are two options, Default or Other. Default is 1 second (factory default). Other is a user-defined time in milliseconds. Select the time field to display a numerical keyboard. A valid entry is 0 to 99999. After entering a valid time, select **ENTER** to return to the **PING/TRACE** parameter screen.

### Payload

**PAYLOAD** is the amount of data sent with the ping packet in bytes. There are two options, Default or Other. Default is 50 bytes (factory default). Other is a user-defined amount of bytes. Select the byte field to display a numerical keyboard. A valid entry is 10 to 50000. After entering a valid number, select **ENTER** to return to the **PING/TRACE** parameters screen.

## Timeout

**TIMEOUT** is the amount of time the **LANEXPERT** waits before a ping response returns. There are two options, Default or Other. Default is 10s (factory default). Other is a user-defined time in seconds. Select the time field to display a numerical keyboard. A valid entry is 1 to 99. After entering a valid number, select **ENTER** to return to the **PING/TRACE** parameters screen.

*NOTE: Press the DOWN arrow on the right of the screen to scroll to the next page of parameters.*

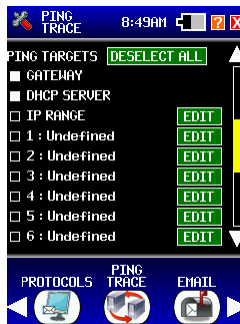

Ping Trace Screen II

## Ping Targets

**PING TARGETS** allows the user to select what the **LANEXPERT** will PING. Select one target, or any combination of targets, from the list. The options are Gateway, DHCP Server, IP Range (user defined), or up to sixteen separate User Defined Targets (Ping List Entries). The Deselect All button clears all the selected choices.

## Gateway

**GATEWAY** allows for the pinging of the established gateway.

## DHCP Server

**DHCP SERVER** allows for the pinging of the established DHCP Server.

---

## IP Range

**IP RANGE** allows for the pinging of a user defined range of IP Addresses. Select the **EDIT** Field to display a numerical keyboard. Select the box to change the IP range. After entering the desired range, select **ENTER** to return to the **PING/TRACE** parameters.

## Ping List Entries 1 to 16

**PING LIST ENTRIES 1 to 16** are user defined. Select any of the numbered choices to edit. Select the **EDIT** field to go the **Ping List Entry** parameter screen. Under Ping List Entry:

- **TARGET** selects how to enter and display the parameters on the list. The choices are IP Address, Name (DNS) or Name (WINS).
- **IP ADDRESS** allows for an entry of a Name and an IP address. Select the editable fields to enter the desired name or number. After entering the desired name and/or number, select **ENTER** to return to the **Ping List Entry** parameters screen.
- **NAME (DNS)** allows for an entry of a Name. Select the editable fields to enter the desired name. After entering the desired name, select **ENTER** to return to the **Ping List Entry** parameters screen.
- **NAME (WINS)** allows for an entry of a Name and an IP. Select the editable fields to enter the desired name. After entering the desired name, select **ENTER** to return to the **Ping List Entry** parameters screen.

To exit the **Ping List Entry** screens, select the **Exit** button in the top right corner to return to the **PING/TRACE** parameters screen.

---

*NOTE: Select another Setup button visible on the screen or by scrolling to the right or left with the white arrows or select the Exit button.*

---

## Discover

To edit or view the parameters for the **SELECTED** profile, select the **DISCOVER** button.



Discover Screen

**Discover** sends out an ARP, NETBIOS and DNS request that actively searches for network devices on a network. When performing the Discover action and the ARP checkbox is selected, the **LANEXPERT** sends ARPs to the entire range of the configured subnet (or the class C subnet if the **LANEXPERT'S** subnet is wider than the configured subnet). If this subnet is the same as the physical network subnet, the first and last IPs are special IPs used for subnet multicasting. Selecting ignore will not send an ARP to them. Here are a few examples of how to configure.

- If you are unsure or if the LanExpert subnet is the actual subnet of the users' network, set both checkboxes (i.e. neither the first nor the last IP will be ARPed).
- If the LanExpert subnet is at the lowermost end of the actual subnet of the users' network, set the IGNORE 1<sup>st</sup> IP and clear the IGNORE LAST IP checkboxes.
- If the LanExpert subnet is at the uppermost end of the actual subnet of the users' network – clear the IGNORE 1<sup>st</sup> IP and set the IGNORE LAST IP checkboxes.
- Otherwise, clear both checkboxes.

---

*NOTE: Sending an ARP to the first and last IP address in a class C subnet may cause a problem if misconfigured.*

---

*NOTE: Select another Setup button visible on the screen or by scrolling to the right or left with the white arrows or select the Exit button.*

---

## Traffic Generation

To edit or view the parameters for the **SELECTED** profile, select the **TRAFFIC GENERATION** button.

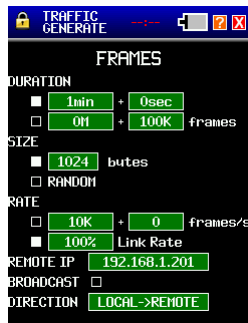

Traffic Generation Screen

**WARNING:** *The LANEXPERT is a high performance tester and can generate a high amount of traffic very quickly. This can take down any network. Psiber is not liable for this action.*

## Duration

**DURATION** has two options; either **TIME** which sends a constant stream of packets from the **LANEXPERT** for a user-defined amount of time or **FRAMES** sends a user-defined amount of packets. Once the defined amount of packets is reached, the **LANEXPERT** will stop sending packets. To change the **PACKET** count, select the editable field buttons next to the word **FRAMES**. This will display a numerical keyboard to change the number of frames in Kilobytes or Megabytes to send. A valid entry is 0 to 9,999K or 0M to 999,999M. After entering a valid number, select **ENTER** to return to the **TRAFFIC GENERATION** parameters screen.

## Size

**SIZE** is the frame size of the packet in bytes. To change the Size, select the editable field button. This will display a numerical keyboard to change each frame size. A valid entry is 64 to 1518. After entering a valid number, select **ENTER** to return to the **TRAFFIC GENERATION** parameters screen. Select **RANDOM** to have a mixture of packet sizes from 64 to 1518 sent from the **LANEXPERT**.

---

## Rate

**RATE** is how fast the stream of frames is being generated by the **LANEXPERT**. To change the Rate of the frames, select the editable field button next to the word **FRAMES/S**. This will display a numerical keyboard to change how fast each frame is generated in kilo frames or frames per second. A valid entry is 0 to 9999 and 0 to 1999K. After entering a valid number, select **ENTER** to return to the **TRAFFIC GENERATION** parameters screen. **LINK RATE** can also be change to a user-defined percentage of the actual link rate To change Link Rate, select the editable field button next to the word **LINK RATE**. This will display a numerical keyboard to change the percentage of the link rate the frames will be sent at. A valid entry is 0 to 100%. After entering a valid number, select **ENTER** to return to the **TRAFFIC GENERATION** parameters screen.

## Remote IP

**REMOTE IP** is a known IP address of a device on the network or a random IP address. If the IP address selected is not a valid address on the network, then the **LANEXPERT** will send out broadcasts frames to the entire network. To change the Remote IP Address, select the editable field button next to the word Remote IP. This will display a numerical keyboard to change the IP Address. After entering the desired IP address, select **ENTER** to return to the **TRAFFIC GENERATION** parameters screen.

## Broadcast

If the **Broadcast** button is enabled then an ARP is generated for the remote IP. If there is a response to the ARP then traffic is generated to the remote IP with the responding MAC address. If there is no response to the ARP then the traffic generated to the remote IP is with a broadcast MAC address (i.e the traffic would generate throughout the network)

## Direction

**DIRECTION** displays **REMOTE->LOCAL** or **LOCAL->REMOTE**. This sends traffic from the Remote unit to the local unit or from the Local unit to the Remote unit. This gives a downstream and an upstream path.

---

**WARNING:** *The LANEXPERT is a high performance tester and can generate a high amount of traffic very quickly. This can take down any network. Psiber is not liable for this action.*

---

---

*NOTE: Select another Setup button visible on the screen or by scrolling to the right or left with the white arrows or select the Exit button.*

---

## Stress Test

To edit or view the parameters for the **SELECTED** profile, select the **STRESS TEST** button.

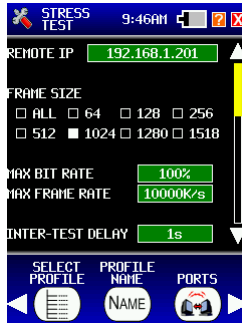

Stress test Screen

### Remote IP

Select the IP address button to enter or change the IP address. The IP address of the second port or another LanExpert must be entered as the destination for the transmitted test packets.

### Frame Size

Select from one to seven of the standard frame sizes. These frame sizes are generated by the LanExpert to test the network. This setting is used for all tests.

### Max Bit Rate

Select the maximum bit rate percentage for testing. Selecting 100% has no effect on the network. The maximum bit rate setting is not used for the Back-to-Back tests.

### Max Frame Rate

Select the maximum frame rate for testing (in integer Kfps). Selecting a very high number, e.g. 10000K, effectively removes the effect. The maximum frame rate setting is not used for the Back-to-Back tests.

### Inter-test Delay

Select the delay between tests to receive test results before performing another test.

---

*NOTE: Press the DOWN arrow on the right of the screen to scroll to the next page of parameters.*

---

## Accuracy

Select one for both throughput and back-to-back to measure the accuracy. The lower the number the faster the test.

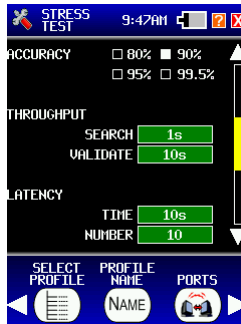

Stress test Screen

## Throughput

- **SEARCH** is the test time for each test while searching for the maximum error-free throughput.
- **VALIDATE** is the validation test time for the final error-free throughput validation and all latency tests.

## Latency

- **TIME** sets the wait time at the end of every test before checking the results. This allows the data to have propagated to the other end and also allows for all intermediate devices to recover.
- **NUMBER** selects the number of Latency tests. This is the number of times the Latency test is repeated.

---

*NOTE: Press the DOWN arrow on the right of the screen to scroll to the next page of parameters.*

---

## Frame Loss

- **STEP** size lowers the frame loss rate percentage. The Source sends traffic at maximum line rate (100%) and then measures if the network dropped any frames. If frames are dropped, the values are recorded, and the test will restart at the next step size down. This test is repeated until there is no frame loss for three consecutive iterations.
- **TIME** sets the maximum number of frames which can be sent.

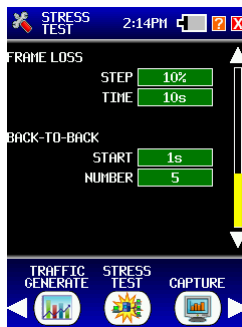

Stress test Screen

## Back-to-back

- **START** selects the Initial Back-to-Back Test Time (in integer seconds). This indirectly sets the starting number of frames sent when performing the Back-to-Back test. The result will always be equal to or smaller than the maximum number of frames which can be sent in this time.
- **NUMBER** selects the number of Back-to-Back tests. This is the number of times the Back-to-Back test is repeated.

---

*NOTE: Select another Setup button visible on the screen or by scrolling to the right or left with the white arrows or select the Exit button.*

---

## Capture

To edit or view the parameters for the **SELECTED** profile, select the **CAPTURE** button.

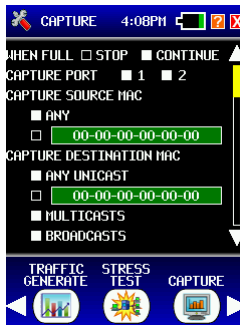

Capture Screen 1

**CAPTURE** allows the user to define a filter to capture a certain frame type. The **LANEXPERT** can capture 1000 packets. Once the **LANEXPERT** reaches 1000 packets, it can **STOP** capturing or **CONTINUE**. If **CONTINUE** is selected, the first packets captured will be the first packets sent out. Select to capture on one or both ports.

### Capture source MAC

**CAPTURE SOURCE MAC** will either capture packets from the user defined Source MAC address entered or **ANY** MAC address. Source MAC address is where the packet originated. To change the Source MAC address, select the editable MAC field button. This will display a Hexadecimal keyboard to change the MAC Address. After entering the desired MAC address, select **ENTER** to return to the **CAPTURE** parameters screen.

### Capture destination MAC

**CAPTURE DESTINATION MAC** will either capture packets from the user defined Destination MAC address entered, any UNICAST, MULTICASTS, or BROADCASTS. Destination MAC address is where the packet is received. To change the Destination MAC address, select the editable MAC field button. This will display a Hexadecimal keyboard to change the MAC Address. After entering the desired MAC address, select **ENTER** to return to the **CAPTURE** parameters screen.

*NOTE: Press the DOWN arrow on the right of the screen to scroll to the next page of parameters.*

## Capture frame types

**CAPTURE FRAME TYPES** allows for the selection of one or a combination for frame types detected. Select RFC894, STP, LLC and/or LLC/SNAP.



Capture Screen 2

## Capture VLAN frames

**CAPTURE VLAN FRAMES** allows for the selection of one or a combination of VLAN options. Select NON-VLAN, ANY and/or a specific VLAN tag. Next to **VLAN**, the user can select or change the **TAG** number. A numerical keyboard screen is displayed. Valid entries are 0 to 4095. If a non-valid entry is chosen, an error message will appear. The screen will then revert back to the keyboard to re-enter a valid number. The **CLEAR** button removes the incorrect digits from the display. After selecting a valid number, select **ENTER** to return to the **CAPTURE VLAN FRAMES** parameters screen.

*NOTE: Press the DOWN arrow on the right of the screen to scroll to the next page of parameters.*

## Capture Primary Protocols

**CAPTURE PRIMARY PROTOCOLS** allows for the selection of either one or a combination of protocols to be detected. Use the list below to select certain protocols or select the ANY button to search all protocols. If there are none, there will be no more parameters to select.

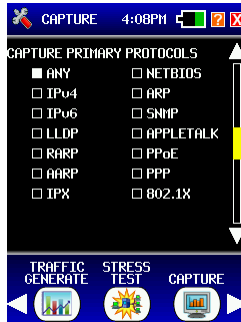

Capture Screen 3

*NOTE: Press the DOWN arrow on the right of the screen to scroll to the next page of parameters.*

## Capture Source IP

**CAPTURE SOURCE IP** allows for the selection to capture from ANY source IP address or a single user-defined source IP address. Select the address button to go to a numerical keyboard screen to enter a source IP address. If a non-valid entry is chosen, an error message will appear. The screen will then revert back to the keyboard to re-enter a valid number. The **CLEAR** button removes the incorrect digits from the display before entering a new address. After entering the desired address, select **ENTER** to return to the **PORTS** parameters screen.

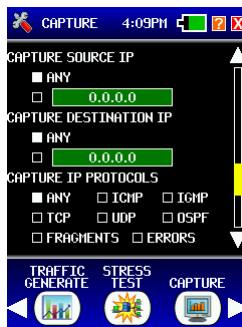

Capture Screen 4

## Capture Destination IP

**CAPTURE DESTINATION IP** allows for the selection to capture from ANY destination IP address or a single user-defined destination IP address. Select the address button to go to a numerical keyboard screen to enter a destination IP address. If a non-valid entry is chosen, an error message will appear. The screen will then revert back to the keyboard to re-enter a valid number. The **CLEAR** button removes the incorrect digits from the display before entering a new address. After entering the desired address, select **ENTER** to return to the **PORTS** parameters screen.

## Capture IP Protocols

**CAPTURE IP PROTOCOLS** allows for the selection of one or a combination of IP protocols to be detected. Select from the list to choose certain protocols or select the ANY button to search all protocols.

*NOTE: Press the DOWN arrow on the right of the screen to scroll to the next page of parameters.*

## Capture UDP/TCP ports

**CAPTURE UDP/TCP PORTS** allows for the selection to capture ERRORS, ANY PORT and/or a user-defined port number. Select to capture UDP and/or TCP packets. Select the port number button to go to a numerical keyboard screen to enter a port number. If a non-valid entry is chosen, error message will appear. The screen will then revert back to the keyboard to re-enter a valid number. The **CLEAR** button removes the incorrect digits from the display before entering a new address. After entering the desired address, select **ENTER** to return to the **CAPTURE UDP/TCP PORTS** parameters screen.

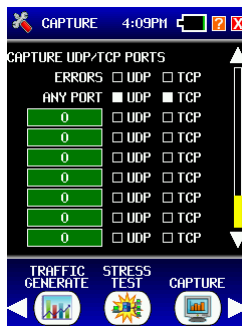

Capture Screen 5

*NOTE: Select another Setup button visible on the screen or by scrolling to the right or left with the white arrows or select the Exit button.*

## Lock

To lock the analyzer, select **LOCK/UNLOCK**.

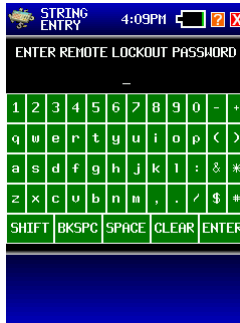

Lock Password Screen

This screen is used to set a password to prevent remote access to the **LANEXPERT**. A full character keyboard is available to enter a desired password. The screen graphic will change to a padlock if the password is correct.

---

*NOTE: Select another Setup button visible on the screen or by scrolling to the right or left with the white arrows or select the Exit button.*

---

## Colors

To edit or view the parameter, select the **COLORS** button.

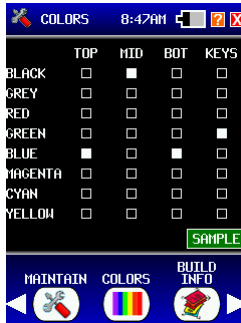

Colors Screen

This screen will change the colors on the display of the Top Area, Middle Area, Bottom Area and Keys. Select the boxes of the desired colors. Colors will automatically update to preview the selections.

---

*NOTE: Select another Setup button visible on the screen or by scrolling to the right or left with the white arrows or select the Exit button.*

---

---

## Build Info

**BUILD INFO** will display Firmware version, Hardware version, Port 1 and Port 2 MAC addresses as well as the Serial Number.

---

*NOTE: Select another Setup button visible on the screen or by scrolling to the right or left with the white arrows or select the Exit button.*

---

## Select Language

**SELECT LANGUAGE** will display the various languages that the **LANEXPERT** supports. Select the desired language for the screens to be represented in that language.

---

*NOTE: Select another Setup button visible on the screen or by scrolling to the right or left with the white arrows or select the Exit button.*

---

# Chapter 4

---

# Analyze Network

This chapter will explain the screens presented for using the **LANEXPERT** to analyze the device under test (i.e. PC, network device).

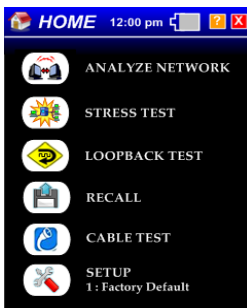

Home Screen LE80

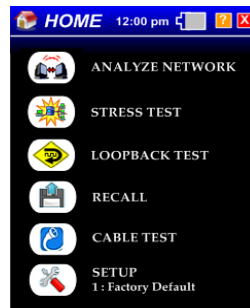

Home Screen LE85

## Preparing to Use the Analyzer

Before selecting the **ANALYZE NETWORK** button on the HOME screen, determine how the **LANEXPERT** is to be connected to the device being tested (i.e. PC, network device, etc.). This will be based on how the analyzer was set up in the Ports Configuration section of the setup.

- **Single Mode** - attach the patch cable to either Port 1 or Port 2.
- **Inline Mode** - attach a patch cable to both Ports 1 and 2.
- **Independent Mode** - attach a patch cable to both Ports 1 and 2.

If only one port is connected while in Inline or Independent Mode, that port will link while the other port continues searching for a link. The Port LED that has not established a link will keep blinking red and the screen will display a "LINKING" message for the unlinked port until a link is established. Only minimum information about the linked port will be displayed. No additional information will be shown unless both ports are connected and a link established.

## Selecting the Test Mode

Select the **ANALYZE NETWORK** button with the stylus on the HOME screen. Notice that both Status Port LEDs are blinking red until a link is established on the connected ports. For detailed information on the LEDs, see Status Indicator section page 2-6.

During the linking process, the only active buttons are **HOME** and **SETUP**. Once a link is established the other buttons will become active.

## Link

The first screen that appears is the **LINK** Screen. This screen will display the partner's capabilities and actual link status.

When Link Signals are detected on either/both Ports, the Link Screen is displayed. The linked Port(s) are shown with the actual link parameters including connection type (LAN or NIC), speed (10/100/1000) and duplex mode (Half or Full).

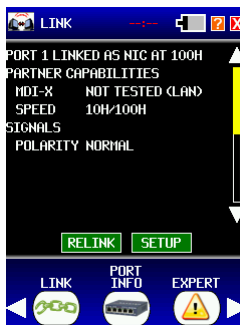

Example Link Screen

## Partner Capabilities

A connection to a network device that can automatically swap the transmit and receive pairs is indicated by AUTO MDI-X. A fixed port is shown as LAN or NIC. The MDI-X mode is provided only if Auto+Detect is selected in **PORTS** Setup. If not, the analyzer displays NOT TESTED. All Speed and duplex modes advertised by the Link Partner are displayed. If a fixed speed is selected then the partners speed will show only that specific fixed speed and not all advertised speeds.

## Signals

Polarity (normal or reversed) is shown for 10/100BaseT links. Master or slave status is shown for gigabit links. Gigabit links require one end to be the master and the other to be a slave.

---

## Relink

In the Data Action Buttons area, pressing **RELINK** will force a re-establishment of the link partner; **note that this also clears all the data collected**. If no link is established within the timeout period configured, a message is displayed in the **EXPERT** Screen but, the unit will attempt to automatically re-link.

## Setup

In the data action button area, pressing **SETUP** provides a quick way of navigating to the **SETUP->PORTS** screen for the presently selected profile. Select the **[X]** exit button in the upper right of the **SETUP** screen to return to the previous screen. For more information on this Port Configuration, see page 3-4.

---

*NOTE: Press the **Down** arrow on the right of the screen to scroll to IP information of the unit.*

---

## Link IP Information

Link IP Information includes MAC address, IP address, Subnet Mask, Gateway IP address and DHCP Server IP address. The WINS (Windows Internet Name Service) name and up to three DNS (Domain Name System) Server IP addresses are also provided if assigned. When the port is configured for DHCP, the lease time and time remaining on the lease are displayed.

---

*NOTE: If some of the information fields are left blank, a longer **EXT SERVER TIMEOUT** can be selected in **PORTS Setup**.*

---

Once a link is established, if the cable is disconnected, the analyzer displays **LINKING** while attempting to find a link partner. If the cable is disconnected and reconnected within the timeout period, the **LANEXPERT** will re-establish a link with the current configurations. The previously collected data is not cleared and new data will be added to the displayed data. If the cable is disconnected and reconnected out of the timeout period, the **LANEXPERT** will connect to a link and the previously collected data is cleared.

---

*NOTE: Select another **Test** button visible on the screen or by scrolling to the right or left with the white arrows or select the **Exit** button.*

---

## Port Info

Select the **PORT INFO** button in the Bottom Area. The **PORT INFO** Screen decodes LLDP and CDP frames which are shown on the screen in the order they were received.

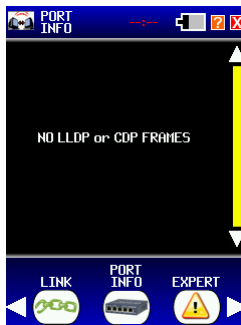

Example Port Info Screen

## LLDP/CDP Frames Decoded

Type 1 - Chassis ID

Subtype 4 - MAC Address followed by the data

All other subtypes list only the subtype number and the data length and no data.

Type 2 - Port ID

Subtype 5 - Port Name followed by the data length followed by the data (up to ~25 characters)

All other subtypes list only the subtype number and the data length and no data.

Type 3 - Time to Live followed by the data followed by the age of the frame in braces

Type 4 - Port Description followed by the data length followed by the data (up to ~25 characters)

Type 5 - System Name followed by the data length followed by the data (up to ~25 characters)

Type 6 - System Description followed by the data length followed by the data (up to ~25 characters)

Type 7 - System Capabilities followed by -

Capable: followed by the list of capabilities (none if none)

Enabled: followed by the list of enabled capabilities (none if none)

Type 8 - Management followed by the data length.

Type 127 followed by the OUI (name if known - otherwise three-byte value) followed by the subtype followed by the data length.

All other types list the type # and the data length only.

## Expert

Select the **EXPERT** button in the Bottom Area. The Problems Screen displays any problems the analyzer detects. The **LANEXPERT** can display up to 50 different problems. One page will include the problem number, the problem detected and the recommendation on how to solve the problem.

A **<NO PROBLEMS DETECTED>** message is displayed until a problem occurs.

### Clear

Select **Clear** in the data action buttons to clear the problems found.

### Expert Messages

The following are problems the **LANEXPERT** will detect and the recommendations for correction:

- (1) **Did not link**  
Recommendations -
  - Check the LanExpert **PORT** settings.
  - Check the cable between the LanExpert and the device.
  - Check that the device is powered.
  - Replace the device.
  
- (2) **Lost link for a total of (Seconds)**  
Recommendations -
  - Check cable between LanExpert and device.
  - Check power to the device.
  - Replace the device.
  
- (3) **High sustained byte traffic**  
Recommendations-
  - Use higher speed or split link into segments.
  
- (4) **High sustained frame traffic**  
Recommendations -
  - Check the MTU settings of all devices.
  - Check for devices generating unexpected traffic.
  - Use higher speed or split link into segments.
  
- (5) **High peak byte traffic**  
Recommendations -
  - Use higher speed or split link into segments.
  
- (6) **High peak frame traffic**  
Recommendations -
  - Check the MTU settings of all devices.
  - Check for devices generating unexpected traffic.
  - Use higher speed or split link into segments.

- (7) **Detected Pause frames when using half duplex**  
Recommendations -  
Check for device not configured for half duplex.  
Check operation of device bridging full to half duplex.  
Use full duplex throughout network.
- (8) **High volume of Pause frames (Type of traffic)**  
Recommendations -  
Use faster devices.  
Split the link into separate segments.
- (9) **High volume (Type) of traffic from (address)**  
Recommendations -  
Check the device for unexpected activity.  
Use higher speed or split link into segments.
- (10) **Could not obtain address from DHCP server**  
Recommendations -  
Check the DHCP server(s).
- (11) **No response from the DNS server(s)**  
Recommendations -  
Check the DNS IP addresses.
- (12) **Could not resolve a WINS name**  
Recommendations -  
If using a WINS server-  
Check the WINS IP address.  
If not using a WINS server-  
Check all computer NetBios names.
- (13) **VoIP device (address) did not authenticate. See VoIP screen for details**  
Recommendations-  
Check configuration of the VoIP device.
- (14) **Detected (#) discarded IP fragments. Can indicate there are multiple paths between devices**  
Recommendations -  
Check configuration of your network and routers.
- (15) **Detected (#) duplicated or overlapping IP fragments**  
Can indicate there are multiple paths between devices.  
Not unusual when the source is outside of local network.  
Recommendations -  
Check configuration of your network and routers.
- (16) **Detected (#) CRC errors within frames**  
Recommendations -  
Check all cables and devices.

- **(17) Detected (#) frame alignment errors**  
Usually caused by a faulty device.  
Can be caused by improper half duplex operation.  
Recommendations -  
Check all devices within the network.
- **(18) Detected (#) undersize frames (runts)**  
Usually caused by a faulty device.  
Can be caused by improper half duplex operation.  
Recommendations -  
Use faster devices.  
Check all devices within the network.
- **(19) Detected (#) oversize frames**  
Usually caused by a faulty device.  
Can be caused by improper half duplex operation.  
Can be caused by using Jumbo frames.  
Recommendations -  
Check all devices within the network.
- **(20) Detected (#) jabber frames**  
Recommendations -  
Check all devices within the network.
- **(21) Detected (#) improperly formatted frames**  
Recommendations -  
Check all devices within the network.
- **(22) Detected (#) improperly sized frames**  
Can be caused by improper half duplex operation by a device.  
Recommendations-  
Check all devices within the network.
- **(23) Detected (#) IP Header errors from (address)**  
Recommendations -  
Check switches and routers between the LanExpert and the device.  
Replace the device.
- **(24) Detected (#) UDP Header errors from (address)**  
Can indicate there are multiple paths between devices.  
Not unusual when the source is outside of local network.  
Recommendations -  
Check switches and routers between the LanExpert and the device.  
Replace the device.

- **(25) Detected (#) TCP Header errors from (address)**  
Recommendations -  
Check switches and routers between the LanExpert and the device.  
Replace the device.
- **(26) Detected (#) ICMP Header errors from (address)**  
Recommendations -  
Check switches and routers between the LanExpert and the device.  
Replace the device.
- **(27) Detected (#) ICMP Unreachable frames**  
Recommendations -  
Check switches and routers between the LanExpert and the device.  
Replace the device.
- **(28) Detected (#) ICMP Unreachable frames**  
Small numbers of these are not unusual. High numbers usually indicate that a device is misconfigured (incorrect server IP or port).  
Recommendations -  
Change the devices for compatibility.
- **(29) Devices on P1 and P2 have mismatched speed capabilities. They will not operate together**  
Recommendations -  
Change the devices for compatibility.
- **(30) Devices on P1 and P2 have mismatched MDI/X capabilities. They will not operate together**  
Recommendations-  
Change the devices for compatibility.
- **(31) Collisions have been detected**  
Recommendations -  
Check devices are properly configured for half duplex operation.  
Change network to only use full duplex.
- **(32) Cable has reversed polarity in 1 (or more) wire pairs**  
Recommendations -  
Check the cable and the device.
- **(33) VoIP device (address) SIP response timeout. See VoIP screen for details**  
Recommendations -  
Check configuration of the VoIP device.  
Check connectivity to SIP server.

## Vitals

Select the **VITALS** button in the Bottom Area. The **VITALS** screen displays Frame information in a List or Bar chart format. While in the List screen, it displays how long the link has been connected (Elapsed Time) and time it has unlinked (Time Unlinked) both in milliseconds. It also displays the Maximum Frame Size received. This screen breaksdown the individual frames collected into good and bad frames. The good frames are then brokendown into unicast, multicast and broadcast with the amount of frames detected of each. Each frame is shown as a percentage of the entire network traffic.

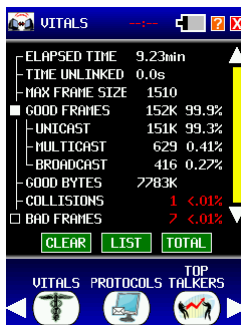

Example Vitals Screen

### Clear

Select **CLEAR** in the data action buttons to clear all the data received.

*NOTE: Linked time will **NOT** be cleared because the link never disconnected*

### List/Chart

Select **LIST** in the data action buttons. A bar chart describing good and bad frames is displayed. These colored bars show the percentage of the total frames received that are multicast or broadcast frames in relation to the total frames. The bars are green if the frames are good and red if the frames are bad. Each bar is logarithmically set in length and is horizontal (there are 0.1%, 1%, 10%, 100% markers shown in the first line of the data area which cannot be changed).

Select **CHART** in the Data Action buttons. The **LIST** will be displayed again showing the good and bad frame counts and percentages.

---

## Total

The **TOTAL** button in the Data Action Area is used to change how the information is presented. The amount of Frames, Good and Bad frames and Good Bytes collected will be presented in the time frame selected. This function works in both the List and Chart mode.

The choices below are how the information can be presented:

- **avg/s** - shows the average of frames and bytes collected per second.
- **/1s** - shows frames and bytes that were collected within the last second. This will update every second.
- **/10s** - shows frames and bytes that were collected within the last 10 seconds. This will update every 10 seconds.
- **/1m** - shows frames and bytes that were collected within the last minute. This will update every minute.
- **Total** - shows all frames and bytes that were collected since the link was established.

## Good Frames

**GOOD FRAMES** are displayed in number of frames and percentage (of total received frames) of good unicast, multicast, and broadcast Ethernet frames received in relation to the total frames. Select the outlined white box to show the breakdown of good frames. Select the filled box to hide the breakdown.

## Good Bytes

**GOOD BYTES** are displayed in number of KB of good multicast and broadcast Ethernet bytes received in relation to the total bytes.

## Bad Frames

**BAD FRAMES** are displayed in red if there are any found. They are displayed in number of frames and percentage (of total received frames) of bad unicast, multicast, and broadcast Ethernet frames received in relation to the total frames. Select the outlined white box to show the breakdown of bad frames. Select the filled box to hide the breakdown.

---

*NOTE: Select another Test button visible on the screen or by scrolling to the right or left with the white arrows or select the Exit button.*

---

## Protocols

Select the **PROTOCOLS** button in the Bottom Area. The protocols screen shows the number of packets and percentage of the total captured data for each protocol. A protocol is added to the protocol list as it is detected. The protocols at the Ethernet Frame level (i.e. RFC894, IEEE 802.2/3, LLC, LCC+Snap, VLAN, etc.) and Ethernet type level (i.e. ARP, IP, IPX, AppleTalk, NetBIOS, IPv6, etc) are displayed first when detected. It shows how many frames received in KB and the percentage of a given protocol in relation to the total number of protocols received.

An outlined white box to the left of the protocol's name means there are more protocols to be displayed under that Ethernet type. The box will be filled in and shows the rest of the protocols under that type. The LanExpert provides protocol names for standard protocols such as LLC, ARP and NETBIOS. Unknown protocols are indicated by the word TYPE with the transmitting port number. Port numbers in hexadecimal format are indicated by an "h" following the number.

If there are too many protocols to display on one screen, press the **Down** arrow on the right of the screen to scroll to the rest of the protocols. The LanExpert can display up to 31 different protocols. After 31 protocols are detected, all additional new protocols are counted together in the 32<sup>nd</sup> slot under OTHERS.

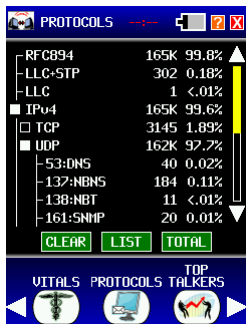

Example Protocols Screen



Example Protocols 2 Screen

---

## Clear

Select **CLEAR** in the data action buttons to clear all the detected protocols.

## List/Chart

Select **LIST** in the Data Action buttons. This will display the percentage of each protocol in a bar chart format. These colored bars show the percentage of the each protocol received. Each bar is logarithmically set in length and is horizontal (there are 0.1%, 1%, 10%, 100% markers shown in the first line of the data area which cannot be changed).

Select **CHART** in the Data Action buttons. The **LIST** will be displayed again showing the good and bad frame counts and percentages.

## Total

The **TOTAL** button in the Data Action Area is used to change how the information is presented. The amount of protocols collected will be presented in the time frames selected. This function works in both the List and Chart mode.

The choices below are how the information can be presented:

- **avg/s** - shows the average of protocols collected per second.
- **/1s** - shows protocols that were collected within the last second. This will update every second.
- **/10s** - shows protocols that were collected within the last 10 seconds. This will update every 10 seconds.
- **/1m** - shows protocols that were collected within the last minute. This will update every minute.
- **Total** - shows all protocols that were collected since the link was established.

---

*NOTE: Select another Test button visible on the screen or by scrolling to the right or left with the white arrows or select the Exit button.*

---

## Top Talkers

Select the **TOP TALKERS** button in the Bottom Area. This displays the MAC address (if found), Registered owner of that MAC address, IP address, name (if found), the number and percentage of transmitted frames on the network.

The **LANEXPERT** lists the devices in order from the highest used bandwidth to the lowest.

### Bandwidth usage

- Over 50% is displayed in RED.
- Between 49.9% to 20% is displayed in ORANGE
- 19.9% and below is displayed in WHITE

This allows the user to quickly determine where the problem might be.

## Clear

Select **CLEAR** in the data action buttons to clear all the detected devices.

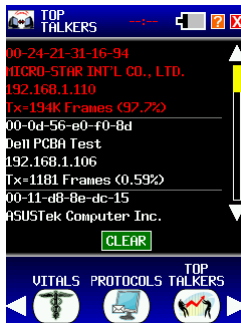

Example Top Talkers Screen

*NOTE: Select another Test button visible on the screen or by scrolling to the right or left with the white arrows or select the Exit button.*

## Devices

Select the **DEVICES** button in the Bottom Area. All devices found by the **LANEXPERT** will be displayed.

*NOTE: This may not be the complete list of devices on the network.*

The first layer of devices are **SERVERS**, **VoIP DEVICES**, **ROUTERS**, **PRINTERS**, and **OTHERS**. Select the outlined white box next to the **SERVERS** names to drill down to see which servers were found. Under **SERVERS**, there may be **DHCP**, **POP3**, **HTTP**, **DNS**, **VoIP/SIP**, etc. Select the outlined white box next to the name of the desired server to see the **MAC** address, Registered owner of that **MAC** address, **IP** address, and number of transmitted and received frames. The data for **VoIP DEVICES**, **ROUTERS**, **PRINTERS** and **OTHERS** has the same format as the **SERVERS** detected. **OTHERS** describes PCs or workstations and anything else not described under the other devices listed above.

## Discover

For a more complete list, select the **DISCOVER** button in the data action buttons. This sends user-defined packets including ARP, NetBios, and DNS to all the devices on the network. This allows for a more detailed list of devices on the network.

## Clear

Select **Clear** in the data action buttons to clear all the devices found.

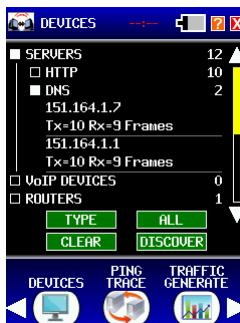

Example Devices Screen

*NOTE: Select another Test button visible on the screen or by scrolling to the right or left with the white arrows or select the Exit button.*

## Ping/Trace

Select the **PING/TRACE** button in the Bottom Area. The PING test is used to verify connectivity, measure round trip communication time, check data integrity, determine a MAC address and search a stored list or a range of IP addresses.

Select **START** in the data action buttons to start Pinging with the selected profile parameters. Select **STOP** in the data action buttons to stop Pinging if using continuous ping. Once the ping test is done, the MAC address of the pinged devices is shown. The **LANEXPERT** also displays the last ping response time in milliseconds, how many Attempted, Lost and Bad pings there were. The next line describes the minimum, average and maximum ping response in milliseconds.

Select **SETUP** in the data action buttons to go straight to the **PING/TRACE** setup to change parameters quickly.

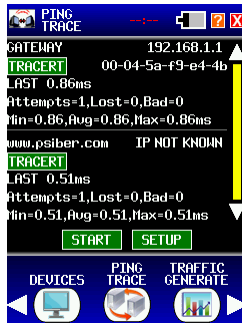

Example Ping Screen

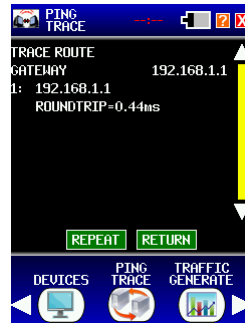

Example Trace Route Screen

## Tracert

Select **TRACERT** button under the device name to trace the route to that device. The device is listed with the number of hops it took the **LANEXPERT** to get to the device. The IP address (if available) is displayed with the roundtrip time in milliseconds. If the **LANEXPERT** cannot resolve the IP address, it displays "IP NOT KNOWN".

## Repeat

Select **REPEAT** to run through the test again.

## Return

Select **RETURN** to go back to the **PING** Screen.

*NOTE: Select another Test button visible on the screen or by scrolling to the right or left with the white arrows or select the Exit button.*

## Traffic Generate

Select the **TRAFFIC GENERATE** button in the Bottom Area. The Traffic Generate Screen displays first how many frames in a Burst or Continuous mode, the number of bytes in each frame and the rate the frames are sent out in seconds.

The Sink IP address is where the frames are sent. If the IP address is not valid, the **LANEXPERT** sends the frames to the entire network as a broadcast. If the IP address is another **LANEXPERT**; received frames, lost frames, and roundtrip time are displayed.

Select **START** to start the test and watch the actual frame and rate the LanExpert uses. Select **SETUP** to change the **TRAFFIC GENERATE** parameters.

### Bandwidth usage

- Over 50% is displayed in RED.
- Between 49.9% to 20% is displayed in ORANGE
- 19.9% and below is displayed in WHITE

This allows the user to quickly determine where the problem might be.



Example Traffic Generate Screen

*NOTE: Select another Test button visible on the screen or by scrolling to the right or left with the white arrows or select the Exit button.*

## Email

Select the **EMAIL** button in the Bottom Area.

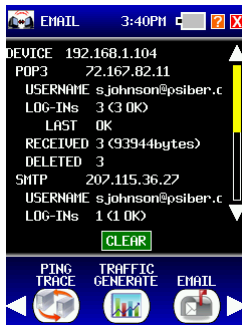

Example Email Screen

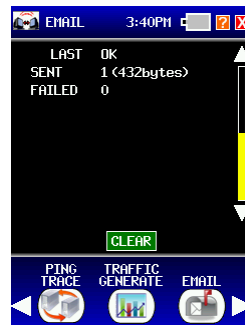

Example Email Screen 2

For the best **EMAIL** information, set the LanExpert to inline mode between the computer sending out the emails and the network.

This screen displays the device IP address that receives an email and the IP address of the email server used (POP3). The **LANEXPERT** displays the email address or the username of the current email session and how many attempts were made to log-in. It describes the Last attempt and whether it was successful or not. Next, the **LANEXPERT** displays how many received and deleted emails and the total number of bytes the emails contained.

For Sending an email from a computer, the **LANEXPERT** displays the IP address of the email server connected (SMTP), Username, attempted log-ins, state of the last attempted log-in and how many sent and failed emails. The email displays the total number of bytes the emails contained.

*NOTE: Select another Test button visible on the screen or by scrolling to the right or left with the white arrows or select the Exit button.*

---

## VoIP

Select the **VoIP** button in the Bottom Area.

**VoIP** uses three different protocols. Detected phone lines could also be video links or data links.

- **SIP** is used for <Session Management> - the VoIP device/line combination registers with the SIP server at intervals (usually every few minutes). In this way, the location and status of the device/line is maintained with the VoIP provider. This authenticates the device/line also. Incoming and outgoing calls are also managed through the SIP server.
- **RTP** is used for the actual <streaming data> (i.e. audio in a phone call) - when a call is made to/from a device/line then the SIP server provides the device/line with the IPs of the RTP server to use. The device/line then sends or receives a data stream to/from the RTP server. Generally, this data is at a consistent rate (usually 50fps for audio) and there are two data streams (one for inbound data, the other for outbound).
- **RTCP** is used to allow each end of an active RTP session to communicate link quality information with each other. Not all RTP devices or servers do this. If this occurs, the sender will generally send one packet every few seconds. This allows the VoIP provider to maintain knowledge of the performance of the network.

There are separate entries for each line/device/server combination. The example on the following page shows one device, one server and two lines. The terminology used in this example is from the definition of SIP.

---

*NOTE: Select another Test button visible on the screen or by scrolling to the right or left with the white arrows or select the Exit button.*

---

## VoIP example



### Line

**LINE** shows the <display name> and SIP <name> for the line. Some devices might not have a <display name>, in which case there is only one line of text shown. This identifies the actual line (i.e. phone line).

### Device

**DEVICE** shows the MAC address of the device and IP address:UDP port used by the device for SIP purposes.

### Registration

**REGISTRATION** shows a count of the attempted and successful registrations of the device/line with the server. These numbers <should> be the same but, they can be slightly off due to network loss and server down times.

**TO** - Shows the IP:UDP port of the server with which the device/line last attempted to register.

**FROM** - Shows the IP:UDP port for the server which the device/line last received registration info from. These might be different because some systems send registrations to one server and receive the response from another.

---

*NOTE: Select another Test button visible on the screen or by scrolling to the right or left with the white arrows or select the Exit button.*

---

## VoIP example - cont.

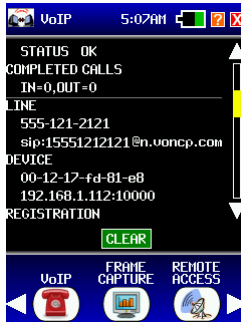

Example VoIP Screen 2

## Registration cont.

**STATUS** shows the textual (informative) part of the last registration status. Generally, this should be alright but, if there is an issue, this will describe the problem (e.g. <UNAUTHORIZED> indicates that the device/line did not correctly authenticate with the server).

## Completed Calls

**COMPLETED CALLS** shows the number of calls made to (IN) and from (OUT) the device/line. Note - this includes calls which did not have a data stream (e.g. if the other end never picked up the call).

This example uses two phone calls to demonstrate. There is a white horizontal line separating the two phone lines.

---

*NOTE: Select another Test button visible on the screen or by scrolling to the right or left with the white arrows or select the Exit button.*

---

## VoIP example - cont.

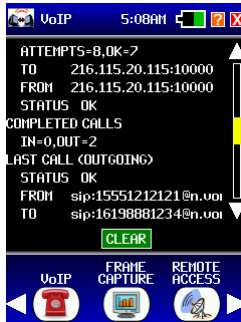

Example VoIP Screen 3

## Last Call

**LAST CALL** - gives information regarding the last call made or the call in progress, if any. If no calls have been made, or if there is no call in progress, this section will not be displayed. The call being made will also be displayed as OUTGOING or INCOMING.

**STATUS** - Shows the last SIP status information for the call progress. Generally, this should be OK, during origination of the call this will show textual status, e.g. <RINGING>.

**FROM** - Shows the SIP <name> of the line which originated the call.

**TO** - Shows the SIP <name> of the line that received the call.

---

*NOTE: Select another Test button visible on the screen or by scrolling to the right or left with the white arrows or select the Exit button.*

---

## VoIP example - cont.



Example VoIP Screen 4

## Media Stream

**MEDIA STREAM** shows the details of the RTP connections for the calls and the protocols (codecs) being used. This is the information negotiated with the SIP server. For each end being used, the IP address and the codec (if known) are displayed.

**SERVER** - shows the server <end> of the RTP link.

**DEVICE** - shows the device <end> of the RTP link - generally, this will be the same IP as the one used by the device for SIP but, not always.

**STATISTICS** - shows the statistics for each of the two RTP data streams as measured by the LanExpert (we do NOT use any received RTCP data). The <DEVICE> column shows the data for the stream coming from the device. The <SERVER> column shows the data for the stream coming from the server.

**RTCP FRAMES** - shows a count of the RTCP frames (if any).

**RTP FRAMES** - shows a count of the number of RTP (i.e. data stream) frames. Since audio is usually 50fps, this can be used to provide an estimate of the length of the call. *Note - the DEVICE and SERVER data should be similar.*

**NOTE:** Select another Test button visible on the screen or by scrolling to the right or left with the white arrows or select the Exit button.

## VoIP example - cont.



Example VoIP Screen 5

## Media Stream - cont.

**RESTARTS, MISORDERS, LOST** and **JITTER** shows the corresponding statistics data for the data stream. The meanings of these are exactly as defined in the SIP RFC.

**RESTARTS** is the number of times that a badly scrambled data stream needed to be restarted (this is bad).

**MISORDERS** is the number of times that frames were received out of order but, not lost (these frames generate poor signal quality, e.g. garbled audio).

**LOST** is the number of frames which were not found in the data stream (these frames generate poor signal quality if they reach a high volume).

**JITTER** is a measure of the timing of the frames (if the frame rate is 50fps for the data stream, then a figure of 1ms corresponds to a 2% uncertainty in the frequency of the audio signal).

*NOTE: Select another Test button visible on the screen or by scrolling to the right or left with the white arrows or select the Exit button.*

# Frame Capture

The **FRAME CAPTURE** screen displays a filtered or non-filtered capture of packets detected by the LanExpert. Select **START** to start capturing packets.

Once a packet is detected it displays which **LANEXPERT** port number the packet is received on, the packet number received from the start of the capture test sequentially and the size of the packet. It also displays the date and time in microseconds when the packet was detected. Select **STOP** to stop the capture.

Select **START** to start the test and watch the actual frame and rate the **LANEXPERT** uses. Select **SETUP** to change the Traffic Generate parameters.

*NOTE: Selecting **START** again will clear detected data for a new capture.*



Example Capture Time Screen



Example Capture Summary Screen

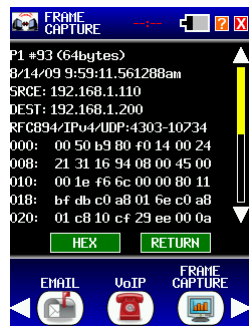

Example Capture Show Screen

## Time / Summary

Select **TIME** to toggle to **SUMMARY** where more information is shown about the packets. Under **SUMMARY** the Source and destination MAC is displayed along with the type of packet detected. Select the **SETUP** button to modify the captured data.

Select the **SHOW** button to display the bytes of the packet in HEX or in ASCII. Select **RETURN** to go back to the other captured packets.

*NOTE: Select another Test button visible on the screen or by scrolling to the right or left with the white arrows or select the Exit button.*

## Remote Access

Select the **REMOTE ACCESS** button in the Bottom Area. The Remote Access Screen displays UDP Sessions and Pings received. The **LANEXPERT** IP address is also shown here.

**UDP SESSIONS** describe the connection to another network device. The **LANEXPERT** displays the IP address and the port number the packet comes from. Also the **LANEXPERT** will tell if the link is Active or Inactive and how many transmitted and received packets between the two devices.

**PINGS RECEIVED** displays what IP address sent the Pings and how many pings received. Select **CLEAR** to clear collected data



Example Remote Access  
Screen

*NOTE: Select another Test button visible on the screen or by scrolling to the right or left with the white arrows or select the Exit button.*

## Inline PoE

Select the **PoE** button in the Bottom Area. This is **INLINE PoE**, which is not the same as the PoE under cable test. By selecting this button, make sure the **LANEXPERT** is in **INLINE** mode or a screen will be displayed saying <Only available when configured in inline mode>. Make sure one side of the **LANEXPERT** is a Powered device and the other side a Power Source.

This screen will show whether the Power is Midspan (power on 45-78), Endspan (power on 12-36) or allspan (power on 12-36 and 45-78) depending on where the voltage is detected.

Inline current is displayed in mA along with the Power in watts and the flow of current going from the source to the device. In this case the current flow is going from P2 and is powering up P1.

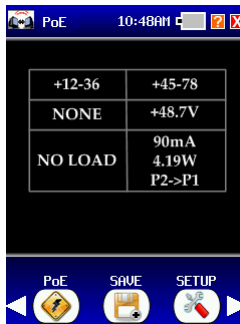

Example Inline PoE  
Screen

*NOTE: Select another Test button visible on the screen or by scrolling to the right or left with the white arrows or select the Exit button.*

## Save

Select the **SAVE** button in the Bottom Area.

**Capture (.CAP files)** is used to store the frames in the Frame Capture mode. Up to 1000 frames in each of 10 memory storage locations can be stored. Once stored the frames must be downloaded to the computer and viewed in the Wireshark protocol analysis software (this is a free software package go to [www.wireshark.org](http://www.wireshark.org) to download the latest version). Select **Internal** to save the data internally in the unit and use the **LANEXPERT** Console Application to extract the data. Select **External** and insert a USB flashdrive to save externally. Give the data a filename no more than eight characters long.

*NOTE: Write down the internal numbers and the external filename to remember where you saved the data.*

*CAUTION: Do NOT remove the flashdrive while saving the data to it. The drive may become unreadable and needs to be reformatted. Saving data may take several seconds. A percentage is shown for its progress and may appear to be "fixed" at times so please be patient.*

**Detectors (.DET files)** is used to store all the information shown in the Link, Problems, Vitals, Protocols, Top Talkers, Devices, Ping/Trace, Email and VoIP. The **LANEXPERT** starts a database of information as soon as the unit Links with the network. Some information is collected without running a specific test. Running other tests adds more information to the data base. This data is saved until the Link is broken and then a new data base is started. Saving **<Detectors>** will save all the information in the data base and when recalled any of the listed tests will show the information in the database at the time it was stored. So it is not limited to just a single test result. Any saved tests can be printed from the Screen Capture in the **LANEXPERT** Console Application.

Select to store the data internally in the **LANEXPERT** and **RECALL** the test results later or save to an external flash drive. Enter a number to where the **LANEXPERT** will save the data internally then press Save. The detector data can only be viewed on a **LANEXPERT**.



Example Save Screen

---

## Setup

Select the **SETUP** button in the Bottom Area. This will display the **SELECTED PROFILES** screen. See how to change parameters under the **SETUP** in chapter 3 page 3-2.

---

*NOTE: Select another Test button visible on the screen or by scrolling to the right or left with the white arrows or select the Exit button.*

---

# Chapter 5

---

# Stress Test

---

This chapter describes how to test the network with the RFC2544 Stress Test. The **LANEXPERT** .

## Understanding RFC2544

The **LANEXPERT** Network Analyzer uses Throughput, Latency, Frame Loss and Back-to-Back tests to measure the performance of a network consisting of one or more active devices.

**Throughput** - defines the maximum number of frames per second that can be transmitted without any errors. The test starts at a mid-range frame rate and then compares the number of transmitted and received frames. If no frames are lost, the rate is increased until frame loss occurs. If frames are lost, the rate is decreased until no frames are lost.

**Latency** - measures the time required for a frame to travel from the originating device through the network to the destination device and then back to the source. The frames are tagged with a time-stamp during transmission. When the tagged frame is received back, the latency is measured.

**Frame Loss** - measures the networks response to overload conditions. Traffic is sent at the maximum line rate and then the number of dropped frames is counted. When dropped frames are detected, the test restarts at a slower rate. This test is repeated until there is no frame loss for two consecutive iterations.

**Back-to-Back Frames** - measures the maximum number of frames received at full line rate before a frame is lost.

## Basic Setup

This section will describe how to configure the **LANEXPERT** for a RFC2544 Stress Test.

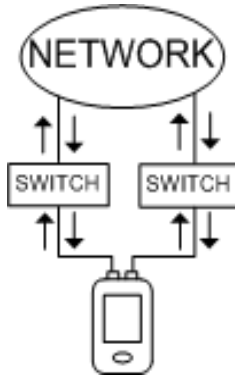

## Stress Test with One LanExpert

Select **SETUP** and select any Profile besides Factory Default under the **Select Profile**. Go to **PORTS** and change the configuration to **INDEP** for Independent mode.

*NOTE: If you are not connected to a network that has DHCP or connected directly into the other port of the LanExpert with a cable, you must select a fixed IP address that has the same subnet mask as Port 2.*

If you are not connected to a network that has DHCP, press the **DOWN** arrow twice to display Port 1 IP address. Select **FIXED** and give PORT 1 an IP address, Subnet and Gateway IP address.

Press the **DOWN** arrow three more times to display Port 2 IP address. Select **FIXED** and give PORT 2 an IP address which is in the same subnet mask as Port 1. Select the same Subnet Mask and Gateway IP address as Port 1.

For Example,

Port 1 IP address 192.125.1.100  
Subnet Mask 255.255.255.0  
Gateway 192.125.1.1

Port 2 IP address 192.125.1.101  
Subnet Mask 255.255.255.0  
Gateway 192.125.1.1

**Make sure to change the Remote IP address to Port 2 IP address. Select STRESS TEST under setup to change the Remote IP.**

## Basic Setup

This section will describe how to configure the **LANEXPERT** for a RFC2544 Stress Test.

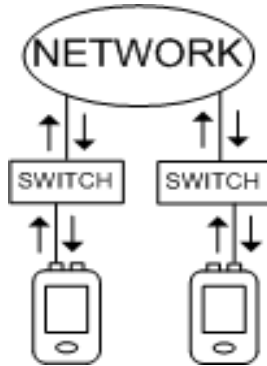

## Stress Test with Two LanExpert

Select **SETUP** on both **LANEXPERT**s and select Factory Default under the **Select Profile**. Press [X] to return to the Home Screen.

Select **Stress Test** and wait for both **LANEXPERT**s to link. On the main **LANEXPERT** (the one where you will press start), Select **Setup** and change the Remote IP address to the other **LANEXPERT** IP address (Remote **LANEXPERT**).

Select **START** to start the Stress test with the configuration set under Stress Test setup. Select the **RESULTS** button to see the results of the test.

---

*NOTE: If you are not connected to a network that has DHCP or connected directly into the other **LANEXPERT** with a cable, you must select a fixed IP address for both of the **LANEXPERT**. Make sure the IP address are within this same subnet mask.*

---

## Stress Test Screen

Select the **STRESS TEST** button from the **HOME** screen. This screen displays the port link connection and the IP address associated with that port. All Stress Test packets are sent to either the second port on the **LANEXPERT** or another **LANEXPERT**. The IP address for the other port or the second LanExpert must be entered in the Stress Test Setup and is shown as the Remote IP address.

There is a button under the Remote IP address labeled **LOCAL-> REMOTE** or **REMOTE -> LOCAL**. This describes where the packets originate from. Selecting **LOCAL-> REMOTE** describes the packet originates from the Local **LANEXPERT** and is sent to the remote **LANEXPERT**. This gives us an upstream configured test.

Selecting **REMOTE -> LOCAL** describes the packet originates from the Remote **LANEXPERT** and is sent to the Local **LANEXPERT**. This gives us a downstream configured test.

Select from one to four test(s) to be performed. The estimated time for each test is given. Select **START** to begin the test(s). Stopping a test before it is complete may give invalid results.



Stress test Screen

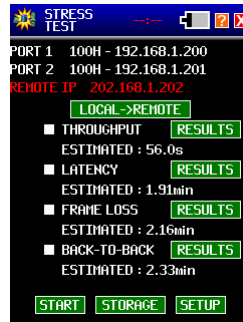

Stress test Screen with invalid IP address

## Start/Stop

Select **START** in the data action buttons to start the selected tests. The **LANEXPERT** tests the connection to the remote IP address to ensure a valid IP was entered. If an invalid IP address was entered then the LanExpert displays an error message saying **<REMOTE DEVICE NOT FOUND>** and returns to the stress test screen where the remote IP is now in red. Select a valid IP address (either from PORT 2 or another **LANEXPERT** on the network). Select **STOP** in the data action buttons to stop the test.

## Stress Test Screen

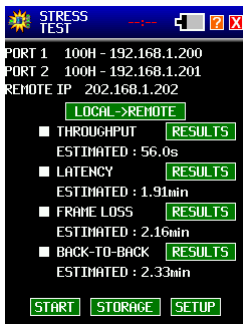

Stress test Screen

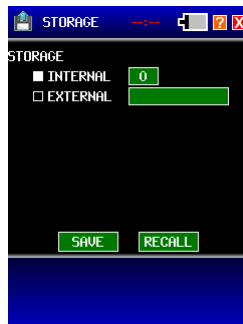

Storage Screen

## Storage

Select **STORAGE** in the Data action buttons to save current test results or recall previously saved test results. The **SAVE** button can only be used when the set of tests have been performed completely and no changes to **SETUP** or test selection have been made. Select an internal or external store number to save the current test data for further analysis or recall previously saved data.

## Setup

Select **SETUP** in the data action buttons to go to the stress test setup to change test parameters.

## Results

Select **RESULTS** in the data action buttons to go to the stress test results screen of a selected test.

## Throughput

Throughput test results are shown as the maximum number of frames transmitted and the percent utilization of the total bandwidth with zero lost frames. One row of data is shown for each enabled frame size (up to 7 rows).

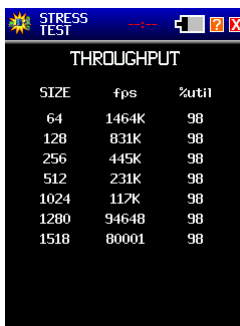

SIZE	fps	%util
64	1464K	98
128	831K	98
256	445K	98
512	231K	98
1024	117K	98
1280	94648	98
1518	80001	98

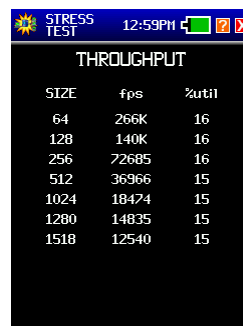

SIZE	fps	%util
64	266K	16
128	140K	16
256	72685	16
512	36966	15
1024	18474	15
1280	14835	15
1518	12540	15

The above screens show two different examples of Stress Tests: The left screen shows the test results when Port 1 of a **LANEXPERT** is connected to a gigabit switch with Port 2 of the same **LANEXPERT** also connected to the gigabit switch. The maximum line rate is 100% of 1000 megabits per second (Mbps). The measured throughput of the switch under test is 98% of the maximum line rate. 98% of 1000 Mbps is 980Mbps showing that the switch is operating at full speed.

The right screen shows the test results when a **LANEXPERT** is connected to a gigabit switch and then converted and transmitted over a microwave link with a speed of 155 megabits per second. The microwave transmission is converted back to copper and connected to a second gigabit switch which is connected to a second **LANEXPERT**. The maximum line rate is limited to the speed of the microwave link of 155Mbps. Calculated utilization is  $155/1000 = 0.155$  or 15.5%. Actual tests measured a 15-16% utilization rate. The difference is due to rounding as only whole numbers are displayed.

*NOTE: Select the red Exit button to go back to the main Stress Test Screen. Select another result button to view results of the other test.*

# Latency

Test results are shown as the minimum, average and maximum latency time (in microseconds) for each size frame that is tested. The total number of packets used in the Latency test is determined by the length of time and number of tests selected in Setup. One row of data is shown for each enabled frame size (up to 7 rows).

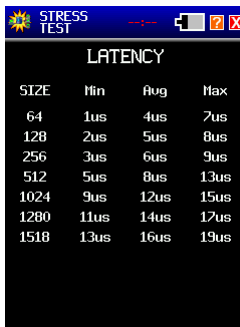

SIZE	Min	Avg	Max
64	1us	4us	7us
128	2us	5us	8us
256	3us	6us	9us
512	5us	8us	13us
1024	9us	12us	15us
1280	11us	14us	17us
1518	13us	16us	19us

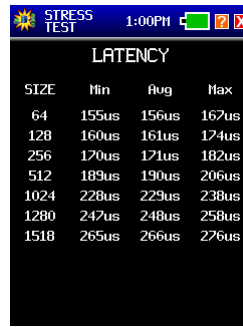

SIZE	Min	Avg	Max
64	155us	156us	167us
128	160us	161us	174us
256	170us	171us	182us
512	189us	190us	206us
1024	228us	229us	238us
1280	247us	248us	258us
1518	265us	266us	276us

When the latency time varies, it causes issues with real-time services. For example, latency variation in VoIP applications would degrade the voice quality. Long latency can also degrade Ethernet service quality. In client-server applications, the server might time out or poor application performance can occur.

The screen on the left shows very small latency times which we would expect from going through only one switch.

The screen on the right shows much longer latency times. This is due to the fact that the sent packets have to go through different medias (i.e. copper and radio link) and speeds to make a roundtrip.

---

*NOTE: Select another Setup button visible on the screen or by scrolling to the right or left with the white arrows or select the Exit button.*

---

## Frame Loss

Test results are shown as Frame Loss percentage versus percent of maximum line speed for each packet size. The test starts at 100% of the line speed and steps down in selectable step sizes until two consecutive steps have 0% frame loss which ends the test. Dashed lines are displayed for line speeds not tested when the 0% frame loss is met.

In the first example below, the test shows 0% loss at both 100% and 90% of the maximum line speed which ended the test. Everything below 90% will also have no frame loss and is not tested. The line speeds less than 90% have dashed lines showing that frame loss rate was not tested.

In the second example below (based on the previous microwave link test), there was 100% frame loss down to 30% of the maximum line rate. Some frames were transmitted correctly from 30% to 20%. Between 20% and 10% transmission reached 0% frame loss. 0% frame loss was expected at about 15.5% because of the 155Mbps microwave link. More accurate results can be attained by changing the Frame Loss setup to a smaller step size such as 1%.

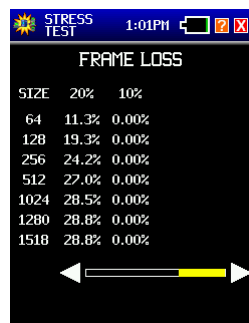
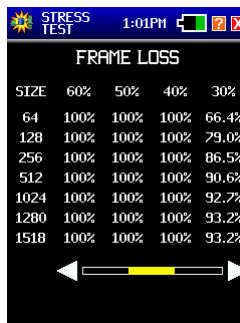
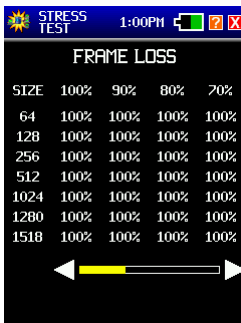
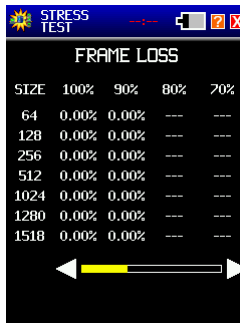

## Back to Back

Test results are shown as the number of frames sent at maximum line speed until a frame was lost. The test is repeated for each selected frame size with one row of data for each frame size (up to 7 rows).



SIZE	BURST
64	3029K
128	1719K
256	921K
512	478K
1024	243K
1280	195K
1518	165K

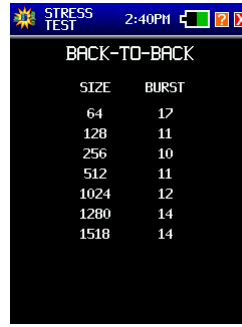

SIZE	BURST
64	17
128	11
256	10
512	11
1024	12
1280	14
1518	14

The screen on the left shows that the LANEXPERT can send a very large amount of back-to-back frames before an error occurs. This shows that our single switch has good buffering capabilities to keep up with the flow of traffic.

The screen on the right shows that the burst of frames isn't as big as what can go through a single switch. Going through multiple devices and medias decrease the amount of back-to-back frames.

*NOTE: Select another Setup button visible on the screen or by scrolling to the right or left with the white arrows or select the Exit button.*

---

## Storage

This section will describe how to Save a RFC2544 Stress Test.

After performing a stress test, select **STORAGE** from the main stress test screen. Select to **SAVE** the stress test data collected internally or externally onto a flashdrive. For saving to flashdrive:

The files are placed into the LANDATA directory, under the name entered on the LanScope when the files were saved. The previous binary file (username.STT) is still saved in the LANDATA directory. This .STT file allows the LanScope to recall the data at a later time.

---

**WARNING: DO NOT DISCONNECT THE USB DRIVE UNTIL THE <SAVING xxx%> TEXT GOES AWAY ON THE LANSCOPE SCREEN.**

**THIS MIGHT TAKE SEVERAL SECONDS TO SAVE AND IT MIGHT APPEAR "STUCK" BUT DO NOT UNPLUG USB. THE USB DRIVE WILL NEED TO BE REFORMATTED IF YOU DO THAT.**

---

The CSV files placed into the sub-directory with the user defined name are as follows -

**TPUT.CSV** - this is the throughput stress test results. If no throughput test was performed then this file does not exist. Each line of the this file has the format <frame size, frames per second, %utilization> (e.g. 64,12345678,99); *NOTE - unlike the display the frames per second data is always in units of 1fps (i.e. it NEVER has a K character on the end and scaled in 1000's).*

**LATENCY.CSV** - this is the latency stress test results. If no latency test was performed then this file does not exist. Each line of the this file has the format <frame size, min, avg, max> (e.g. 64,5,5,6); *NOTE - unlike the display, the data is always in integer microseconds.*

**LOSS.CSV** - this is the frame loss test results. If no frame loss test was performed then this file does not exist. The first line has the format 0,%,%,%.... where each % is the percentage frame rate for the corresponding column. The remaining lines have the format <frame size,loss rate,loss rate>. Where the loss rate is in integer percent (*NOTE - if the % character is missing then the data was not actually measured*).

**BTB.CSV** - this is the back-to-back test results. If no back-to-back test was performed then this file does not exist. Each line of this file has the format <frame size, max frame burst>.

*NOTE - Stress test data saved (internal or external) using this version or an earlier version can be recalled and then resaved with this version in order to generate the CSV files.*

---

**WARNING: DO NOT SAVE DATA COLLECTED FROM AN ABORTED STRESS TEST.** Tests not actually performed might yield random data in the CSV files.

---

# Chapter 6

---

# Cable Test

This chapter will explain the screens presented as you use your **LANEXPERT 80** to perform Port ID, Tone, Length, Wiremap and PoE tests. This section is for **LANEXPERT 80 ONLY**.

**Warning:** Cable test is **ONLY** performed on Port 2. Do not connect anything into Port 1 while performing cable tests. Psiber is not liable for misuse of these ports.

Select **CABLE TEST** from the HOME screen with the stylus.

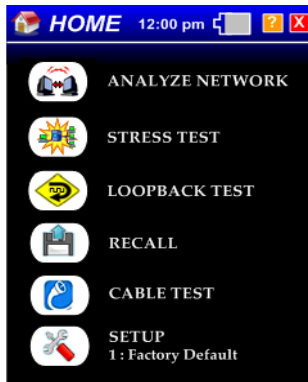

Home Screen LE80

## Port Identification

**PORT ID** is used to determine which port of a hub or switch is wired to a particular wall jack by blinking the Link LED on the port. The blink rate is adjustable for compatibility with most switches and hubs. Select the rate at which the LED will blink either SLOW, MEDIUM, FAST, or FASTEST. Once a link is established, the box will flash the chosen blink rate. **NO LINK** will display in the box if nothing is connected to Port 2. Select **START** to run the test.

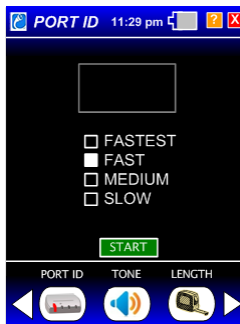

## Tone

**TONE** is used to locate a punchdown or trace a cable using a CT-15 probe (Optional). Select the tone cadence and frequency by selecting the box next to the tone desired. Select **START** to run the test.



*NOTE: Select another Test button visible on the screen or by scrolling to the right or left with the white arrows or select the Exit button.*

## Length

**LENGTH** measures and displays the distance to an open or short of each wire pair in a cable. (Please disconnected Wiremap Terminator prior to starting the length measurement.) Change the NVP for the connected cable by selecting the up and down arrow next to the NVP number. The highest NVP is 74 and the lowest is 65. Change the feet to meters by selecting the FEET button. Select **START** to run the test.

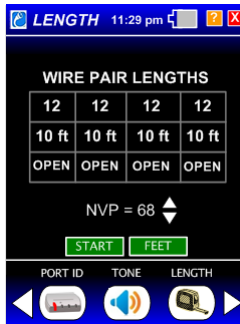

**Warning:** The far end of the cable under test should be disconnected from a port or Wiremap Terminator prior to starting the length measurement.

**NOTE:** Select another Test button visible on the screen or by scrolling to the right or left with the white arrows or select the Exit button.

## Wiremap

**WIREFMAP** verifies proper cable wiring and detects split pairs. Connect the Wiremap Terminator to the cable under test prior to selecting **START**. Select **START** to run the test.

If the Wiremap Terminator is not connected all pairs will display OPEN and a message appears saying <NO TERMINATOR FOUND>. If an error is found the incorrect numbers display in red on the right and a message is displayed inbetween the colored wires.



Example - Good cable



Example - Split Pair on 12-36

**Warning:** Cable test is **ONLY** performed on Port 2. Do not connect anything into Port 1 while performing cable tests. Psiber is not liable for misuse of these ports.



Example - Crossed 12-36 cable



Example - Crossed 12-36 shielded cable

**NOTE:** Select another Test button visible on the screen or by scrolling to the right or left with the white arrows or select the Exit button.

## PoE

**PoE** tests for IEEE Standard Power. The **LANEXPERT** displays the wire pairs that are powered, the voltage measured and the wire pair polarity. Power detected on pairs 12-36 is called an Endspan. Power detected on Pairs 45-78 is called Midsapn. Power detected on all pairs is called Allspan. Select **TEST** to run the test.



For Inline Current measurement, press [X] to get back to the Home Screen. Select **SETUP** and change the profile to be inline. Next go to **ANALYZE NETWORK** from the **HOME** screen and go to the **PoE** test. For further information see chapter 4 page 4-26.

---

*NOTE: Select another Test button visible on the screen or by scrolling to the right or left with the white arrows or select the Exit button.*

---

# Chapter 7

---

# Loopback

This chapter will explain the screens presented as you use your **LANEXPERT** to test for loopback mode on the **LE80 and LE85**.

The Loopback sends traffic to its own IP address through a remote device. This remote device must be configured in an external loopback mode to send the packets back to the LanExpert. In a reflector mode, the remote swaps the source and destination addresses. In loopback, the packets are not handled by the remote MAC they are just passed from the receive portion of the phy to the transmit portion and the source and destination addresses are unchanged. The two LanExpert ports can both be independent source devices but do not provide the external loopback function. This is a way to determine whether the external device is working correctly or a way to pin down a failing node in a network.

Select **LOOPBACK TEST** from the HOME screen with the stylus. The **LANEXPERT** starts looking for a link connection on either port. Once the **LANEXPERT** links the Status Indicators (LEDs) for the Ports will turn to a solid color depending on the speed it is connected. (i.e. Red = 10Mbit, Orange = 100Mbit and Green = 1000Mbit).



Home Screen LE85



Loopback Start Screen

## Setup for Loopback Mode

Press **SETUP** from the Loopback main screen to view the configurable loopback parameters. Change Duration, Packet size and Frame Rate to fit all types of networks.

**DURATION** shows the actual time the test takes to complete. Once the defined amount of packets is reached or the time has completed, the LANEXPERT will stop sending packets. Select either a specific time in minutes and seconds or enter a number of frames. To change the duration, select the editable field button with either the time or frames. This will display a numerical keyboard to change the number of frames in Kilobytes or Megabytes or the time in minutes or seconds. A valid entry is 0 to 9,999K or 0M to 999,999M or 0 to 9999 minutes or 0 to 999 seconds. After entering a valid number, select **ENTER** to return to the **LOOPBACK MAIN** screen.

**SIZE** is the frame size of the packet in bytes. To change the Size, select the editable field button. This will display a numerical keyboard to change each frame size. A valid entry is 64 to 1518. After entering a valid number, select **ENTER** to return to the **LOOPBACK MAIN** parameters screen. Select **RANDOM** to have a mixture of packet sizes from 64 to 1518 sent from the **LANEXPERT**.

**RATE** is how fast the stream of frames is being generated by the **LANEXPERT**. Select either frames/s or the link speed rate. To change the rate of the frames, select the editable field button. This will display a numerical keyboard to change how fast each frame is generated in frames per second or Kilo frames per second. A valid entry is 1 to 999. After entering a valid number, select **ENTER** to return to the **LOOPBACK MAIN** screen. Press the **EXIT** button to get back to the **LOOPBACK MAIN** screen.

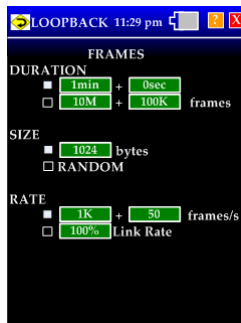

Loopback Setup Screen

# Loopback Test

Once the parameters are set, press **START** on the Loopback main screen to start running the loopback test.

Once the **START** button has been pressed, the LanExpert will show the **SIZE** in bytes of each packet, the **AVERAGE RATE** at which the packets will be sent out and **FRAMES** transmitted and received by the LanExpert. This screen will also display the number of lost frames and the percentage of lost frames to total packets. The **REMAINING** time is also displayed to allow the user to know how much longer the test will run before it is finished.

The **ROUNDTRIP** is given for Minimum, Average and Maximum time it take for the packet to travel from the LanExpert through the loopback device and back to the LanExpert.



Loopback Start Screen without loopback device



Loopback Start Screen with loopback device

# Chapter 8

---

# Recall Save Data

This chapter will explain the screens presented as you use your **LANEXPERT** to recall internal or external saved data.

Select **RECALL** from the HOME screen with the stylus. The **LANEXPERT** starts looking for a link connection on either port. Once the **LANEXPERT** links the Status Indicators (LEDs) for the Ports will turn to a solid color depending on the speed it is connected. (i.e. Red = 10Mbit, Orange = 100Mbit and Green = 1000Mbit).

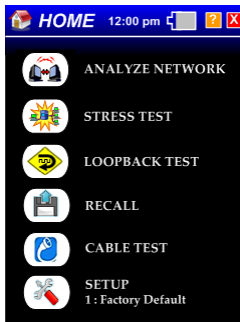

Home Screen LE80



Home Screen LE85

**NOTE:** The **LANEXPERT** can not recall saved capture files. These files have to be opened with Wireshark or equivalent on a computer.

**NOTE:** The **LANEXPERT** does not need to connect to the network to see saved data. Connecting to the network allows the user to get an IP address from the DHCP server to plug into the **LANEXPERT** Console Application on the computer.

---

## Recall Internal Data

Select the internal number field to enter the saved data number. This is where you saved the data under Analyze Network. Press **ENTER** to return back to the **RECALL** screen. Press **RECALL** to find the data.

If the saved number location is valid then the screen information will be displayed. This will look identical to the analyze network button except no new information is being filled in. Select the buttons to navigate to the saved data. Press the **EXIT** button to get back to the **RECALL** screen.

If the saved number location is not valid then a message is displayed above the **RECALL** button saying **INVALID DATA**. Enter a new saved data number or press **EXIT** to get back to the HOME screen.

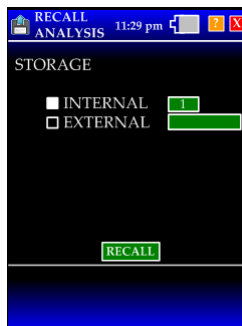

Recall Screen

---

*NOTE: Note- the Mode screen graphic in the upper left corner is the Recall symbol and not the Analyze network symbol.*

---

## Print Recalled Data

Select **Remote Access** in the Operating Mode buttons on the bottom of the screen to display the **LANEXPERTs** IP address. Enter this IP address into the **LANEXPERT** Console Application. Press the Screen Capture tab to Print saved screens.

---

## Recall External Data

Plug in the USB flashdrive where the saved data from the Analyze Network was stored. Select the external name field to enter the saved data filename. This is where you saved the data under Analyze Network. Press **ENTER** to return back to the **RECALL** screen. Press **RECALL** to find the data.

If the saved filename is valid then the screen information will be displayed. This will look identical to the analyze network button except no new information is being filled in. Select the buttons to navigate to the saved data. Press the **EXIT** button to get back to the **RECALL** screen.

If the saved filename is not valid then a message is displayed above the **RECALL** button saying **INVALID DATA**. Enter a new saved filename or press **EXIT** to get back to the HOME screen.

---

*NOTE: The Mode screen graphic in the upper left corner is the Recall symbol and not the Analyze network symbol.*

---

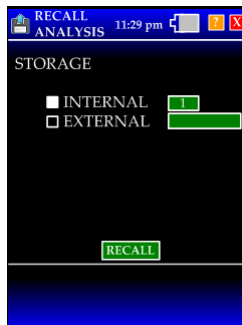

Recall Screen

---

*NOTE: Large USB flashdrive that are nearly full could take up to 15-20 seconds to be recognized.*

---

## Print Recalled Data

Select **Remote Access** in the Operating Mode buttons on the bottom of the screen to display the **LANEXPERTs** IP address. Enter this IP address into the **LANEXPERT** Consol Application. Press the Screen Capture tab to Print saved screens.

# Chapter 9

---

# Technical Support

---

This chapter will explain how to get answers to questions about the **LANEXPERT**.

First, go to **<http://www.psiber.com/de/home/products/network-analyzer/lanexpert/faqs-general.html>** to view Frequently Asked Question about the LanExpert.

If you do not see your question, select **Submit question** to enter a unique question. Our technical support department views submitted questions everyday and will answer questions as soon as possible.

## **For further assistance in the United States:**

Address: 7075-K Mission Gorge Rd  
San Diego, CA 92120  
Email: [support@psiber.com](mailto:support@psiber.com)  
Phone: 1-619-287-9970  
Fax: 1-619-287-9978

## **For further assistance in Europe:**

Address: Felix-Wankel-Str.4  
82152 Krailling (bei Munchen)  
Email: [support@psiber-data.com](mailto:support@psiber-data.com)  
Phone: +49 (0) 89 89 136060  
Fax: +49 (0) 89 89 136066

# Chapter 10

---

# Update Firmware

---

This chapter will explain the steps on how to use the Console Application to Update the firmware for your **LANEXPERT**.

Select **ANALYZE NETWORK** from the HOME screen with the stylus. The **LANEXPERT** starts looking for a link connection on either port. Once the **LANEXPERT** links the Status Indicators (LEDs) for the Ports will turn to a solid color depending on the speed it is connected. (i.e. Red = 10Mbit, Orange = 100Mbit and Green = 1000Mbit).

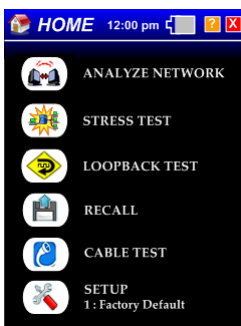

Home Screen

## Install The Console Application

The **LANEXPERT** Console Application requires that the .NET Framework version 3.5 is installed on your computer. If you do not have the .NET Framework version 3.5 installed on your computer you will need to install it first. You can skip step 1 if you already have the .NET Framework version 3.5 installed on your computer. Plug the flashdrive (that came with the unit) into the computer and open the folder.

### INSTALLATION PROCEDURE

1. Install the .NET Framework 3.5 on your computer by clicking on the doNetFx35setup.exe file in this directory. You will have to be connected to the Internet for the installation process. After the install, you may be required to reboot your computer. If you choose to reboot later, then reboot your computer after completing installation step 2.
2. Install the **LANEXPERT** Console Application by clicking on the LANExpertInstaller.exe file in this directory. Follow the instructions on the Setup Wizard to install the Console Application.

When the installation is complete, double click the **LANEXPERT** Console Application on your desktop.

Find the newest firmware version on the the **LANEXPERT** page in the Downloads section.

Example of a Downloads Tab contents:

### *CONSOLE AND FIRMWARE DOWNLOADS:*

“The latest firmware for the LANEXPERT™ is v1.66

Download and read first: Instructions

To update to this version click on the word FIRMWARE and download the files shown and follow the directions. The Release Notes will help you to find out what is new.”

## LanExpert Firmware Update Instructions

(Definition: XX = latest available version)

0. Before starting the LanExpert firmware update procedure, ensure that the LanExpert is fully charged, or is powered using the AC adapter. Also, that the LanExpert console application is downloaded and installed onto your computer. If not, download the app from Psibers web site and install.
1. Create a LanExpertFW directory on your hard drive. Save the Update\_1\_XX.zip file into the LanExpertFW directory. Extract the Update\_1\_XXa.lanexpert and Update\_1\_XXb.lanexpert file to the LanExpertFW directory. The directory should contain three files; Update\_1\_XXa.lanexpert, Update\_1\_XXb.lanexpert and Update\_1\_XX.zip.
2. Turn on the LanExpert and select factory default (for DHCP networks) or select Profile 2 and assign the LanExpert a static IP address.
3. Connect the LanExpert to your network and press Analyze Network. After establishing a connection, press the down arrow to view the IP address.
4. Open the LanExpert Console Application from your computer.
5. Enter the LanExpert IP address into the Console Application.
6. Press Connect. Make sure the Connection Status reads "Connected" and the LanExpert Response displays the current firmware version.
7. Select the Update Firmware tab on the Console Application.
8. Select the Browse button on the Console Application.
9. Search for Update\_1\_XXa.lanexpert in the LanExpertFW directory on your hard drive.
10. Once selected, press Start to update your LanExpert.
11. Once the LanExpert Console application displays Complete, turn off the LanExpert.
12. Turn the LanExpert back on.
13. Verify that the firmware version displayed in the Welcome Screen is 1.XX. Select Setup>Build Info to see the firmware version is the same.
14. Press Analyze Network. After establishing a connection, press the down arrow to view the IP address.
15. Enter the LanExpert IP address into the Console Application.
16. Press Connect. Make sure the Connection Status reads "Connected" and the LanExpert Response displays the current firmware version.
17. Select the Update Firmware tab on the Console Application.
18. Select the Browse button on the Console Application.
19. Search for Update\_1\_XXb.lanexpert in the LanExpertFW directory on your hard drive. (Note: the LanExpert must have firmware version 1.33 or higher before part b can be uploaded)
20. Once selected, press Start to update your LanExpert.
21. Once the LanExpert Console application displays Complete, turn off the LanExpert.

# Appendix A

---

# Connecting the Analyzer

---

## Single Ended

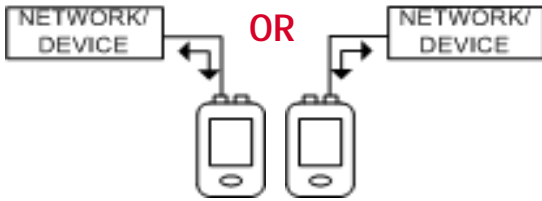

## Independent

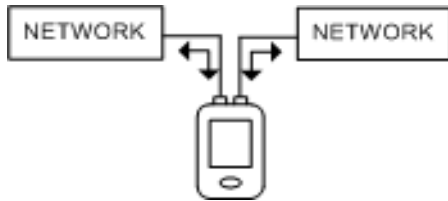

## Inline

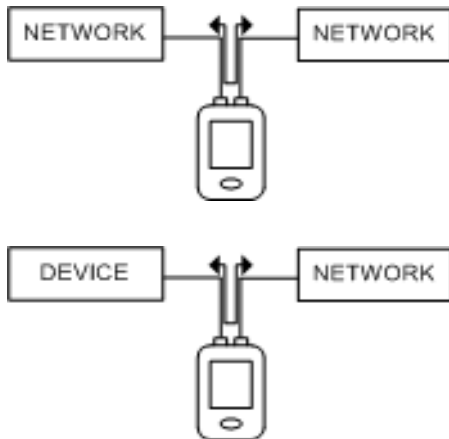

# Connecting the Analyzer

---

## Stress Test

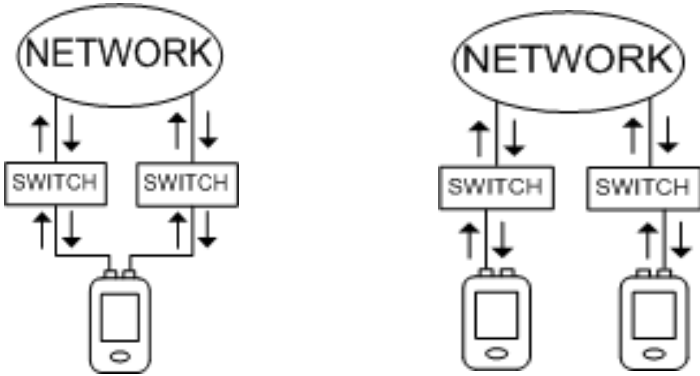

## Cable Test (LE80 ONLY on Port 2)

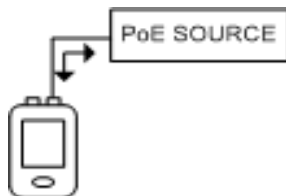
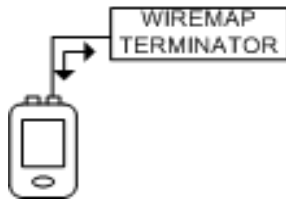

# Connecting the Analyzer

---

## Loopback Test

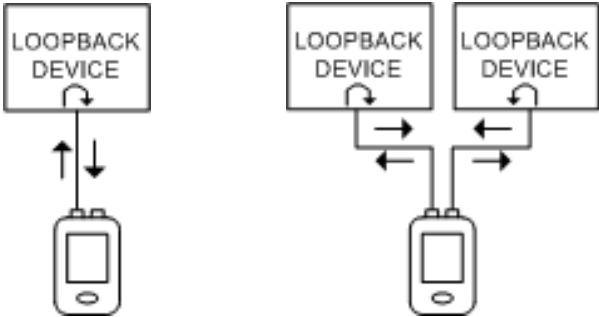

# Appendix B

---

# Graphics

---

## Upper Display Area Graphics



Home Graphic. This is the graphic in the upper left corner when the home screen is being shown on the display.



Analyze Network Graphic. This is the graphic in the upper left corner when any of the ANALYZE NETWORK screens is being shown on the display.



Cable Test Graphic. This is the graphic in the upper left corner when any of the CABLE screens is being shown on the display.



Setup Graphic. This is the graphic in the upper left corner when any of the SETUP screens is being shown on the display.



Lock Graphic. This is the graphic in the upper left corner that replaces the SETUP graphic when the user locks the unit with a password.



Power Graphic. This is the graphic in the upper left corner when the power settings screen is being shown on the display (i.e. after the battery symbol has been pressed).



Date/Time Graphic. This is the graphic in the upper left corner when the date/time settings screen is being shown on the display (i.e. after the time has been pressed).



Numeric, Name, MAC, IP and Ping List Entry Graphic. This is the graphic in the upper left corner when any numeric or name entry screen is being shown on the display.



Exit Graphic. This is the exit button/graphic in the top right of almost all screens.



Help Graphic. This is the HELP button/graphic in the top right of almost all screens.

---

## Home Screen Graphics



Analyze Network Button. This is the graphic for the ANALYZE NETWORK button on the home screen.



Recall Button. This is the graphic for the RECALL button on the HOME screen.



Stress Test Button. This is the graphic for the STRESS TEST button on the HOME screen.



Cable Test Button. This is the graphic for the CABLE TEST button on the home screen.



Setup Button. This is the graphic for the SETUP button on the home screen and the SETUP button at the bottom of all ANALYZE NETWORK screens.

## Setup Graphics - Bottom Area



Select Profile Button. This is the graphic for the SELECT PROFILE button at the bottom of the SETUP screens.



Set Profile Name Button. This is the graphic for the PROFILE NAME button at the bottom of the SETUP screens.



PORTS Button. This is the graphic for the PORTS button at the bottom of the SETUP screens.



Protocols Button. This is the graphic for the PROTOCOLS button at the bottom of the ANALYZE NETWORK screens and also at the bottom of the SETUP screens.



Ping/Trace Button. This is the graphic for the PING/TRACE button at the bottom of the ANALYZE NETWORK screens and also at the bottom of the SETUP screens.



Discover Button. This is the graphic for the DISCOVER button at the bottom of the SETUP screens.

## Setup Graphics - Bottom Area - cont.



Traffic Generate Button. This is the graphic for the TRAFFIC GENERATE button at the bottom of the ANALYZE NETWORK screens and also at the bottom of the SETUP screens.



Frame Capture Button. This is the graphic for the CAPTURE button at the bottom of the ANALYZE NETWORK screens and also at the bottom of the SETUP screens.



Lock Button. This is the graphic for the LOCK button at the bottom of the SETUP screen.



Touch Panel Button. This is the graphic for the TOUCH PANEL button at the bottom of the SETUP screens.



Colors Button. This is the graphic for the COLORS button at the bottom of the SETUP screens.



Build Info Button. This is the graphic for the BUILD INFO button at the bottom of the SETUP screens.



Select Language Button. This is the graphic for the SELECT LANGUAGE button at the bottom of the SETUP screens.

## Analyze Network Graphics - Bottom Area



Link Button. This is the graphic for the LINK button at the bottom of the ANALYZE NETWORK screens.



Problems Button. This is the graphic for the PROBLEMS button at the bottom of the ANALYZE NETWORK screens.



Vitals Button. This is the graphic for the VITALS button at the bottom of the ANALYZE NETWORK screens.



Protocols Button. This is the graphic for the PROTOCOLS button at the bottom of the ANALYZE NETWORK screens and also at the bottom of the SETUP screens.

---

## Analyze Network - Bottom Area - cont.



Top Talkers Button. This is the graphic for the TOP TALKERS button at the bottom of the ANALYZE NETWORK screens.



Devices Button. This is the graphic for the DEVICES button at the bottom of the ANALYZE NETWORK screens.



Ping/Trace Button. This is the graphic for the PING/TRACE button at the bottom of the ANALYZE NETWORK screens and also at the bottom of the SETUP screens.



Traffic Generate Button. This is the graphic for the TRAFFIC GENERATE button at the bottom of the ANALYZE NETWORK screens and also at the bottom of the SETUP screens.



Email Button. This is the graphic for the EMAIL button at the bottom of the ANALYZE NETWORK screens and also at the bottom of the SETUP screens.



VoIP Button. This is the graphic for the SECURITY button at the bottom of the ANALYZE NETWORK screens and also at the bottom of the SETUP screens.



Frame Capture Button. This is the graphic for the CAPTURE button at the bottom of the ANALYZE NETWORK screens and also at the bottom of the SETUP screens.



Remote Sessions Button. This is the graphic for the REMOTE SESSIONS button at the bottom of the ANALYZE NETWORK screens.



PoE Inline Button. This is the graphic for the PoE Inline button at the bottom of the ANALYZE NETWORK screens. This is a <Button> graphic.



Save Button. This is the graphic for the SAVE button at the bottom of the ANALYZE NETWORK screens.

---

## Cable Test - Bottom Area



Port ID Button. This is the graphic for the PORT ID button at the bottom of the CABLE TEST screens.



Tone Button. This is the graphic for the TONE button at the bottom of the CABLE TEST screens.



Length Button. This is the graphic for the LENGTH button at the bottom of the CABLE TEST screens.



Wiremap Button. This is the graphic for the WIREMAP button at the bottom of the CABLE TEST screens.



PoE Button. This is the graphic for the PoE button at the bottom of the ANALYZE NETWORK screens and the CABLE TEST screens.

# Appendix C

---

# UTC Time Zones

Abbreviation	Full name	Location	Time zone
<u>A</u>	Alpha Time Zone	Military	UTC + 1 hour
<u>ACDT</u>	Australian Central Daylight Time	Australia	UTC + 10:30 hours
<u>ACST</u>	Australian Central Standard Time	Australia	UTC + 9:30 hours
<u>ADT</u>	Atlantic Daylight Time	North America	UTC - 3 hours
<u>AEDT</u>	Australian Eastern Daylight Time or Australian Eastern Summer Time	Australia	UTC + 11 hours
<u>AEST</u>	Australian Eastern Standard Time	Australia	UTC + 10 hours
<u>AKDT</u>	Alaska Daylight Time	North America	UTC - 8 hours
<u>AKST</u>	Alaska Standard Time	North America	UTC - 9 hours
<u>AST</u>	Atlantic Standard Time	North America	UTC - 4 hours
<u>AWDT</u>	Australian Western Daylight Time	Australia	UTC + 9 hours
<u>AWST</u>	Australian Western Standard Time	Australia	UTC + 8 hours
<u>B</u>	Bravo Time Zone	Military	UTC + 2 hours
<u>BST</u>	British Summer Time	Europe	UTC + 1 hour
<u>C</u>	Charlie Time Zone	Military	UTC + 3 hours
<u>CDT</u>	Central Daylight Time	Australia	UTC + 10:30 hours
<u>CDT</u>	Central Daylight Time	North America	UTC - 5 hours
<u>CEDT</u>	Central European Daylight Time	Europe	UTC + 2 hours
<u>CEST</u>	Central European Summer Time	Europe	UTC + 2 hours
<u>CET</u>	Central European Time	Europe	UTC + 1 hour
<u>CST</u>	Central Summer Time	Australia	UTC + 10:30 hours
<u>CST</u>	Central Standard Time	Australia	UTC + 9:30 hours
<u>CST</u>	Central Standard Time	North America	UTC - 6 hours
<u>CXT</u>	Christmas Island Time	Australia	UTC + 7 hours
<u>D</u>	Delta Time Zone	Military	UTC + 4 hours
<u>E</u>	Echo Time Zone	Military	UTC + 5 hours
<u>EDT</u>	Eastern Daylight Time	Australia	UTC + 11 hours
<u>EDT</u>	Eastern Daylight Time	North America	UTC - 4 hours
<u>EEDT</u>	Eastern European Daylight Time	Europe	UTC + 3 hours
<u>EEST</u>	Eastern European Summer Time	Europe	UTC + 3 hours
<u>EET</u>	Eastern European Time	Europe	UTC + 2 hours
<u>EST</u>	Eastern Summer Time	Australia	UTC + 11 hours
<u>EST</u>	Eastern Standard Time	Australia	UTC + 10 hours
<u>EST</u>	Eastern Standard Time	North America	UTC - 5 hours
<u>F</u>	Foxtrot Time Zone	Military	UTC + 6 hours

# UTC Time Zones

<u>G</u>	Golf Time Zone	Military	UTC + 7 hours
<u>GMT</u>	Greenwich Mean Time	Europe	UTC
<u>H</u>	Hotel Time Zone	Military	UTC + 8 hours
<u>HAA</u>	Heure Avancée de l'Atlantique	North America	UTC - 3 hours
<u>HAC</u>	Heure Avancée du Centre	North America	UTC - 5 hours
<u>HADT</u>	Hawaii-Aleutian Daylight Time	North America	UTC - 9 hours
<u>HAE</u>	Heure Avancée de l'Est	North America	UTC - 4 hours
<u>HAP</u>	Heure Avancée du Pacifique	North America	UTC - 7 hours
<u>HAR</u>	Heure Avancée des Rocheuses	North America	UTC - 6 hours
<u>HAST</u>	Hawaii-Aleutian Standard Time	North America	UTC - 10 hours
<u>HAT</u>	Heure Avancée de Terre-Neuve	North America	UTC - 2:30 hours
<u>HAY</u>	Heure Avancée du Yukon	North America	UTC - 8 hours
<u>HNA</u>	Heure Normale de l'Atlantique	North America	UTC - 4 hours
<u>HNC</u>	Heure Normale du Centre	North America	UTC - 6 hours
<u>HNE</u>	Heure Normale de l'Est	North America	UTC - 5 hours
<u>HNP</u>	Heure Normale du Pacifique	North America	UTC - 8 hours
<u>HNR</u>	Heure Normale des Rocheuses	North America	UTC - 7 hours
<u>HNT</u>	Heure Normale de Terre-Neuve	North America	UTC - 3:30 hours
<u>HNY</u>	Heure Normale du Yukon	North America	UTC - 9 hours
<u>I</u>	India Time Zone	Military	UTC + 9 hours
<u>IST</u>	Irish Summer Time	Europe	UTC + 1 hour
<u>K</u>	Kilo Time Zone	Military	UTC + 10 hours
<u>L</u>	Lima Time Zone	Military	UTC + 11 hours
<u>M</u>	Mike Time Zone	Military	UTC + 12 hours
<u>MDT</u>	Mountain Daylight Time	North America	UTC - 6 hours
<u>MESZ</u>	Mitteeuropäische Sommerzeit	Europe	UTC + 2 hours
<u>MEZ</u>	Mitteleuropäische Zeit	Europe	UTC + 1 hour
<u>MSD</u>	Moscow Daylight Time	Europe	UTC + 4 hours
<u>MSK</u>	Moscow Standard Time	Europe	UTC + 3 hours
<u>MST</u>	Mountain Standard Time	North America	UTC - 7 hours
<u>N</u>	November Time Zone	Military	UTC - 1 hour
<u>NDT</u>	Newfoundland Daylight Time	North America	UTC - 2:30 hours
<u>NFT</u>	Norfolk (Island) Time	Australia	UTC + 11:30 hours
<u>NST</u>	Newfoundland Standard Time	North America	UTC - 3:30 hours
<u>O</u>	Oscar Time Zone	Military	UTC - 2 hours
<u>P</u>	Papa Time Zone	Military	UTC - 3 hours

# UTC Time Zones

---

<u>PDT</u>	Pacific Daylight Time	North America	UTC - 7 hours
<u>PST</u>	Pacific Standard Time	North America	UTC - 8 hours
<u>Q</u>	Quebec Time Zone	Military	UTC - 4 hours
<u>R</u>	Romeo Time Zone	Military	UTC - 5 hours
<u>S</u>	Sierra Time Zone	Military	UTC - 6 hours
<u>T</u>	Tango Time Zone	Military	UTC - 7 hours
<u>U</u>	Uniform Time Zone	Military	UTC - 8 hours
<u>UTC</u>	Coordinated Universal Time	Europe	UTC
<u>V</u>	Victor Time Zone	Military	UTC - 9 hours
<u>W</u>	Whiskey Time Zone	Military	UTC - 10 hours
<u>WDT</u>	Western Daylight Time	Australia	UTC + 9 hours
<u>WEDT</u>	Western European Daylight Time	Europe	UTC + 1 hour
<u>WEST</u>	Western European Summer Time	Europe	UTC + 1 hour
<u>WET</u>	Western European Time	Europe	UTC
<u>WST</u>	Western Summer Time	Australia	UTC + 9 hours
<u>WST</u>	Western Standard Time	Australia	UTC + 8 hours
<u>X</u>	X-ray Time Zone	Military	UTC - 11 hours
<u>Y</u>	Yankee Time Zone	Military	UTC - 12 hours
<u>Z</u>	Zulu Time Zone	Military	UTC